

**Development of Polymer Network of Phenolic and Epoxies Resins mixed with Linseed Oil: Pilot Study**

**H Ku, F Cardona, D Rogers, and J-C Munoz**

Faculty of Engineering and Surveying and  
Centre of Excellence in Engineered Fibre Composites,  
University of Southern Queensland, Australia.

H Ku, F Cardona, D Rogers, and J-C Munoz, Development of Polymer Network of Phenolic and Epoxies Resins mixed with Linseed Oil: Pilot Study, Journal of Materials Engineering and Performance, 2010, Vol. 19, No. 6, pp. 912-919.

Corresponding Author:

Title : Dr.  
Name : Harry Siu-lung Ku  
Affiliation : Faculty of Engineering and Surveying,  
University of Southern Queensland.  
Tel. No. : (07) 46 31-2919  
Fax. No. : (07) 4631-2526  
E-mail : [ku@usq.edu.au](mailto:ku@usq.edu.au)  
Address : Faculty of Engineering and Surveying,  
University of Southern Queensland,  
West Street, Toowoomba, 4350,  
Australia.

**Abstract:** Epoxy resin was mixed with phenolic resins in different percentages by weight. Composite 40/60 means the proportion by weight of epoxy resin is 40 percent. It was found that only composites 50/50 and 40/60 could be cured in ambient conditions. Dynamic mechanical analysis showed that only these two composites form interpenetrating polymer network. The addition of linseed oil to the two resins results also in the formation of interpenetrating network irrespective of proportion by weight of the resins; the mechanical properties will only be better when the percentage by weight of epoxy resin is higher; the aim of reducing cost and at the same time maintaining the mechanical properties cannot be fully achieved because epoxy resin is much more expensive than its counterpart.

**Keywords:** Epoxy resin, phenolic resin, flexural test, dynamic mechanical thermal analysis and linseed oil.

## **Introduction**

The emerging use of fibre composite materials and technologies in civil and structural engineering has created opportunities in the development of 'smarter' composites. A research centre in the University of Southern Queensland utilises thermosetting resins, e.g. epoxies, vinylesters and phenolics, in nearly all of its work. While the mechanical properties of thermosetting composites are good, their major drawback is their brittleness.

A major focus of polymer research work conducted at the centre is to improve the toughness of thermosetting resins. There are many well-established techniques to toughen these resins – thermoplastic modification, core-shell particle additives, rubber [CTBN (carboxyl-terminated butadiene/acrylonitrile copolymer), ATBN (amine terminated butadiene acrylonitrile)]

adducts, etc. These approaches are always too expensive for civil engineering applications. The centre uses epoxy resins for many of its projects, which have no thermal resistance and burn with ease. Phenolics resins, on the other hand, have very good thermal properties and are fire resistant. An idea to make a composite with interpenetrating polymer network of phenolic and epoxies resins came out from members of the centre. The 'smart' composite will bring the advantages of both resins together. Mechanical and thermal tests were carried out to characterize the behaviour of the 'smart' composites to see if they were useful to the centre.

### **Hyrez 202 – Epoxy resin**

Hyrez 202 is the name given to the epoxy resin made by the centre. It is a mixture of 'part A', which is a mixture of commercial epoxy resins, and 'part B', which is a mixture of different commercial hardeners. Experiments showed that the best proportion of the resin is 80% by weight of part A and 20% by weight of part B. Hyrez 202 provides low cost epoxy resin. In general, the physical properties of epoxy resins are density = 1100 to 1500kg/m<sup>3</sup>; tensile modulus = 3 to 5 GPa; tensile strength = 60 to 80 MPa; flexural stress at break = 100 to 150 MPa; elongation at break = 2 to 5%; shear strength = 30 to 50 MPa and temperature of bending (under load) = 290°C [1].

Epoxy resins are one of the most important classes of thermosetting polymers. These networks have many desirable properties which include high tensile strength and modulus, excellent chemical and corrosion resistance and good dimensional stability. Consequently, these materials are widely used for many important applications such as coatings, structural adhesives, reinforced plastics and matrix for advanced composite materials [1-4].

Unfortunately, these highly crosslinked networks are inherently brittle and consequently have limited applications in areas where high fracture strength or thermal resistance were required. Epoxies are thermosetting resins based on the epoxiran groups which are able to condense with reagents with mobile hydrogen and amine groups; crosslinking leads to a solid structure.

### **Phenolic resin**

The centre uses Cellobond® J2027L phenolic resin. It is a brown prepolymer with a phenolic odour. The viscosity is around 2800 cP at 25 °C. Its composition consists of phenol/formaldehyde resin, 30 to 60%, phenol, 1 to 10%, formaldehyde, 1 to 5% and water, 30 to 60%. The polymer, based on phenolic resin, is Phenol-formaldehyde (PF). PF resins are the major adhesives used for bonding wood panels for exterior applications. The PF adhesive resins are used primarily in the production of soft plywood, oriented strand board, and wafer board. The PF resins are formed by the reaction of phenol with formaldehyde. By varying the reaction time, reaction temperature, catalyst type, and the ratio of formaldehyde to phenol, a number of adhesive systems with different properties can be produced [5].

Phenolic resins are thermosetting polymers with high chemical resistance and thermal stability but low toughness and mechanical strength. Moreover, phenolic resins have intrinsic resistance to ignition, low generation of smoke and relatively low cost. On the other hand, they are characterized by a complex process of polymerization with the condensation of water and formaldehyde and formation of voids. Therefore, the processing of phenolic materials requires careful temperature control and gradual heating to allow continuous elimination of volatiles and to reduce defects in final components. Normally, the time required for these operations is incompatible with common industrial processes. Initially

formaldehyde reacts with phenol to form hydroxymethyl derivatives. As the reaction proceeds, reactions also take place between the hydroxymethyl groups and the aromatic ring carbons of phenol or another hydroxymethyl group to form methylene linkages.

### **Phenolic catalysts**

In general, there are three catalysts for the resin: Phencat 15, Phencat 382 and AP-3. Phencat 15 is a fast action acid catalyst. The reaction with phenolic resins is strongly exothermic. It is toxic and causes burns if contacted. Its composition consists of xylenesulfonic acid, 70 to 90%, phosphoric acid, 10 to 20% and water, 1 to 10%. Phencat 382 is a slow action acid catalyst. The reaction with phenolic resin is exothermic. It is toxic and dangerous. Its composition consists of phosphoric acid, 40 to 80% and water 20 to 60%. AP-3, the exact the composition is not known but is a commercial mixture of different acids. The reaction with phenolic resins is strongly exothermic. It has a high toxicity and burns the skin.

Phencat 15 cures the mixture of phenolic and epoxy resins better if the percentage by weight of epoxy resin is less. However, when the percentage of epoxy resin increases, the reaction becomes too exothermic and fast, and 'moss' was formed. Moreover, there is another reaction taking place because Phencat 15 consists of xylenesulfonic acid which reacts with epoxy resin. There are two exothermic reactions taking place at the same time, resulting in the formation of moss [6]. Phencat 382 is a slow phenolic catalyst so it is difficult for it to cure a mixture with a few percentages by weight of phenolic resin; it reacts well with a mixture of 50/50 or more phenolic resin if its percentage by weight is 5% or more. In addition, it does not contain xylenesulfonic acid and no moss was found except for composites 20/80 and

10/90 but it could be easily controlled. On account of the above grounds, Phencat 382 was used for this study.

### **Linseed oils**

Linseed oil is amber in colour with a recognisable odour; it is fatty oil extracted from the cotyledons and inner coats of the seeds of flax (linseed). The raw oil is extracted from the seeds by pressing. In its raw form, it is light in colour, but when it is boiled it turns darker and thicker.

Linseed oil is used to protect wood and is a major drying ingredient in high quality oil paints and varnishes. Linseed oil is used to provide protection and finish on wooden furniture and decks of boats. It stabilises the surface of concrete and reduces the formation of dust and prevents corrosive breakdown of steel reinforcing rods. It is also used in the making of linoleum, oilcloth, artist colours and some printing inks. The residue and pulp are used in animal feeds, as a nutritional supplement that is high in omega-3 fatty acids. The oil polymerizes or oxidises more readily when heated [1]. The iodine value related to linseed oil is a measure of the unsaturation of the fats and the oils and is expressed in centigrams of iodine absorbed per gram of sample (% iodine absorbed) [3].

Linseed oil is a blend of glycerin of saturated and unsaturated fatty acids. The saturated fatty acids are not very reactive, the unsaturated one are much more reactive. The unsaturated molecules contain double bond and there are one or more alkenes functional groups along the chain. The molecule has two or more points in its structure which is capable of supporting other atoms [1]. The epoxydized reaction consists of the opening of the C-C double bond and

replacing it by a C-O-C cycle (oxirane ring). The epoxydized double bond is a pre-polymer way of synthesis.

## Experiments

### *Flexural test*

Flexural test provides values for the modulus of elasticity in bending  $E_B$ , flexural stress  $\sigma_f$ , flexural strain  $\epsilon_f$  and the flexural stress-strain response of the material. The main advantage of a three point flexural test is the ease of the specimen preparation and testing. However, this method has also some disadvantages: the results of the testing method are sensitive to specimen and loading geometry and strain rate [4, 7]. Flexural modulus is calculated from the slope of the stress against deflection curve [7]. Flexural test is often done on relatively flexible materials such as polymers, wood and composites. There are two types of the test: 3 point flexural test and 4 point flexural test. Three point bending test will be used in this project. In this test, the area of uniform stress is quite small and concentrated on the centre loading point. Consider a rectangular beam, on which a simple flexural force is exercised in the centre of the beam with a load of P as depicted in Figure 1. The standard used is ISO 14125:1998(E) [8]. The centre uses a universal machine MTS Alliance RT/10 at 10kN couple with the software TESTWORK 4. The dimensions of the specimens were 250 mm x 10 mm x 4 mm and tested at a crosshead of 4 mm/min.

The equation used for calculating the flexural stress,

$$\sigma_f = \frac{3PL}{2bh^2} \quad (1)$$

The equation used for calculating the flexural strain,

$$\varepsilon_f = \frac{6Dh}{L^2} \quad (2)$$

The equation used for calculating the Young's modulus,

$$E_B = \frac{L^3 m}{4bh^3} = \frac{\text{Flexural strength}}{\text{Flexural strain}} \quad (3)$$

where:  $\sigma_f$ : stress in outer fibre at midpoint, MPa;

$\varepsilon_f$ : strain in the outer surface, %;

$E_B$ : modulus of elasticity in bending, MPa;

P: load at a given point on the load deflection curve, N;

L: support span, mm;

b: width of test beam, mm;

h: depth of test beam, mm;

D: maximum deflection of the centre of the beam, mm;

m: slope of the tangent to the initial straight line portion of the load deflection curve, N/mm.

### ***Dynamic Mechanical Thermal Analysis (DMTA)***

DMTA is a technique used to study and characterize materials. It is most useful for observing the visco-elastic nature of polymers. Two methods are currently used. One is the decay of free oscillations and the other is forced oscillation. Free oscillation techniques involve applying a force to a sample and allowing it to oscillate after the force is removed. In this project, forced oscillation was employed. Forced oscillations involve the continued application of a force to the sample. An oscillating force is applied to a sample of material and the resulting displacement of the sample is measured. This method is the most commonly



used one today. Samples can be either solids or melts. Most solids are tested by linearly applying strains, and melts or liquids are normally tested in shear. The sample deforms under the load. From this, the stiffness of the sample can be determined, and the sample modulus can be calculated. By measuring the time lag in the displacement compared to the applied force it is possible to determine the damping properties of the material. The time lag is reported as a phase lag, which is an angle. The damping is called  $\tan \delta$ , as it is reported as the tangent of the phase lag. Visco-elastic materials such as polymers typically exist in two distinct states. They exhibit the properties of a glass (high modulus) at low temperatures and those of a rubber (low modulus) at higher temperatures. By scanning the temperature during a DMA experiment change of state, the glass transition or alpha relaxation, can be observed. The glass transition temperature ( $T_g$ ) is often measured by DSC (Differential Scanning Calorimetry), but the DMA technique is more sensitive and yields more easily interpreted data. DMA can also be used to investigate the frequency (and therefore time) dependent nature of the transition. This is useful as the degree of dependence is specific to the transition type.  $T_g$  has a strong dependence on frequency but melting is frequency independent; DMA can also resolve sub- $T_g$  transitions, like beta, gamma, and delta transitions as the DSC technique is not sensitive enough to pick them up in many materials. In addition, DMA gives modulus values. Frequency is constant and the temperature is varied [9].

In the test, an oscillating force is applied to a sample while the temperature is varied the resulting displacement of the sample is measured. The sample dimension used in the test was 60 mm x 10 mm x 4 mm; the frequency of oscillation was 1 Hz. UNIVERSAL ANALYSIS 2000, the software used, carries out the calculations. From these experiments, graphs of tangent delta loss and storage modulus were produced.

Samples with different proportion of epoxy and phenolic resin were mixed in a take-away box. Part A and part B of the Hyrez 202 were first mixed in calculated proportion by weight; phenolic J2027L and Phencat 382 were then added and mixed with Hyrez 202 [9]. The mixture was then cured in ambient conditions for 4 hours and then post-cured for 4 hours at 60 °C and another 4 hours at 100 °C. It is then cut and sanded to a good surface finish for DMA (dynamic mechanical analysis) and flexural strength tests. Only one sample is required for the DMA and 5 samples for the flexural test.

Later, Epoxydised Linseed Oil (58%) [ELO (58%)] was added to epoxy resin; when ELO (58%) was mixed with epoxy resin, the colour changed to purple, which was a sign of chemical reaction and the network was formed. The curing and post-curing time was 12 hours at ambient conditions followed by 4 hours at 80 °C and then heated up to 150 °C. Table 1 illustrates composites with different percentage by weight of epoxy and phenolic resins with linseed oil pre-mixed with epoxy resin; the weight of part A and part B of Hyrez 202 were also varied. Each time, the same weight of part B of the Hyrez 202 was maintained to compare the action of ELO (58%) on part A.

Finally, phenolic resin was first mixed with ELO (58%) and then the catalyst was added. In other box (container), parts A and B of Hyrez 202 were mixed. Finally, contents of the two boxes were mixed altogether. The same curing conditions were kept. Table 2 illustrates composites with different percentages by weight of epoxy and phenolic resins with linseed oil pre-mixed with phenolic resin.

## Results and discussions

Table 3 shows the results of ambient cured and ambient plus post-cured of the two resins mixed together. It can be found that mixtures with higher percentage by weight of phenolic resin did not cure at ambient conditions and stayed as liquid. However, it was cured after heating in an oven but bubbles were found. For samples with a lot of epoxy, moss appeared a few minutes after mixing. It appears that only composites 50/50 and 40/60 were homogeneous. All other samples, except the pure resins, were not good materials.

When the proportion by weight of Hirez 202 was higher, only 'moss' was obtained due to the strong catalyst, which reacted very fast and some other reactions that were not expected might be present. When the proportion of phenolic resin by weight was higher, samples were damaged by the appearance of bubbles. This may be due to too high curing temperature. The evolution of water and formaldehyde during curing could promote bubbles, microcracking and internal stresses in the final products. Therefore, the processing of phenolic materials requires temperature control to reduce defects in the final components.

Figures 2 (a) and (b) show the results of dynamic mechanical thermal analysis (DMTA) tests, which verify that mixture of epoxy and phenolic resins is an interpenetrating polymer network because two peaks were found; one peak was very large which proved the presence of a network based on epoxy (the lower temperature) and a smaller peak illustrated the presence of a network based on phenolic (the higher temperature).

Figure 3 (a) shows the stress-strain curves of Hyrez 202. The results were similar in trend with those found by other researchers [10]. Figure 3 (b) shows composite with 80% by weight of part A and 20% by weight of part B; it was a brittle composite, but the epoxy resin was a ductile material [Figure 3 (b)].

Figure 4 shows the variation of glass transition temperature ( $T_g$ ) of composites of epoxy and phenolic resins with varying percentage by weight of ELO (58%). It can be found that the  $T_g$  is not very affected by the amount of ELO (58%). However, with composites 80/20, 70/30 and 30/70, the  $T_g$  started to decrease if the ELO (58%) by weight was more than 30%. In another similar study, it was found that the glass transition temperature of epoxy resin decreased with increasing amount of ELO. The lowest value was obtained when the percentage by weight of ELO was also 30%, which was in line with the current study [11].

Figure 5 illustrates the decrease of storage modulus of composites of epoxy and phenolic resins with varying percentage by weight of ELO (58%). The drop rebounded when the percentage by weight of ELO (58%) was over 30%. The change was most significant with the composite 70/30, the storage modulus dropped from 2260 MPa at 0% of ELO (58%) to 230 MPa at 30% of ELO (58%); the change was nearly nine times. The result agreed with the fact that ELO (58%) acted like a plasticizer and the elastic characteristic of the material, which traduced to storage modulus, decreased.

Figure 6 shows the decrease of flexural modulus of composites of epoxy and phenolic resins with varying percentage by weight of ELO (58%). For all composites, the samples showed brittle behaviour. For most of the samples, the flexural modulus decreased linearly to

1000MPa. For the sample 60/40, the flexural modulus at 0% ELO (58%) was 2700 MPa and it fell to 700MPa at 40% of ELO (58%), a fall of nearly four times.

Figure 7 illustrates the strain at break of epoxy and phenolic resins with varying percentage by weight of ELO (58%). Composites 80/20, 70/30, 50/50, 30/70 showed a slight increase of strain at break (%) with increasing percentage by weight of ELO (58%). Composites 60/40 and 40/60 showed a slight decline of strain at break (%) but the values rebounded when the ELO (58%) was over 30%. No general trend for the curves can be traced.

Figure 8 illustrates the peak flexural stress of composites of epoxy and phenolic resins with varying percentage by weight of ELO (58%) and they were all different. For 30/70, 40/60 and 60/40 composites, it increased a little bit for 10% of ELO (58%) and then it decreased with more ELO (58%). For other samples, it decreased immediately with the addition of ELO (58%). In addition to being a plasticizer, a team of researchers found that the linseed oil reacted with phenolic resin and became a portion of the phenolic structure, which was a high-quality friction material [12].

From all the analysis, it was found that the ELO (58%) acted as a plasticizer. However, the strain at break was only 2% and the addition of ELO (58%) seemed not to increase the toughness of the composite. The best material is composite 40/60. When the proportion of phenolic resin was increased, properties became better. The post-curing temperature of 150°C brought about cracks in the material when there was more phenolic resin.

Yue et al. [13] internally toughened novel phenolic resin by epoxidized soybean oil (ESO). The resulting resin with good toughness and thermal stability was used as the matrix resin of

copper clad laminate (CCL). FT-IR was employed to characterize the molecular structure of the modified phenolic resin and SEM was used to observe the micro morphology of the resin intersections. The properties of CCLs prepared with the modified phenolic resin were also studied to determine the optimal processing conditions. Finally, the corresponding toughening mechanism was investigated. It was demonstrated that the toughening relied mainly on the triethanolamine-catalyzed etherification reaction between phenol hydroxyl and ESO, and the chain extension polymerization between ESO and multi-amine, which brought about long-chain ESO epoxy grafting onto the phenolic resin prepolymer. Moreover, it was found that the ESO-toughened phenolic resin possessed optimal performance at an ESO content of 30% and a curing agent content of 7%; the flexible ESO epoxy with significant toughening effect could crosslink with the phenolic resin to form an internally toughened network for improving the solderleaching resistance of the CCL.

## **Conclusions**

Without the addition of linseed oil to the mixture of epoxy and phenolic resins, only composites 50/50 and 40/60 will be cured at ambient conditions and form the interpenetrating polymer network. Since only composites with higher proportion of epoxy resin have better mechanical properties, the aim of reducing cost is not fully achieved.

The epoxidized linseed oil is really a plasticiser. With epoxy resin, ELO can mix with the composite well if the phenolic resin was no more than 20 % by weight and gave better mechanical properties. However, adding ELO did not improve the properties as it was expected. The way in which ELO (58%) was added was unimportant as the properties did not seem to change. A mixture of phenolic and epoxy resins gives good properties only if the

proportion by weight of epoxy resin is high. In the projects done in the centre, fire resistance is an important factor and epoxy reduces this a lot. Therefore, it can be argued that the composites produced in this research are more suitable for friction and coating material.

## References

1. Berthelot, J-M, Matériaux composites comportement mécanique et analyse des structures, édition Masson, 1992. (Berthelot, J-M, Composite materials: Mechanical behaviour and analysis of the structures, Masson edition, 1992).
2. ISO 3001:1999, Plastics. Epoxy compounds. Determination of epoxy equivalent.
3. AOCS, AOCS (American Oil Chemists' Society) official methods Cd 1d-92 reapproved 1997.
4. Wikipedia, The free encyclopaedia, Epoxy resin, [http://en.wikipedia.org/wiki/Epoxy\\_resin](http://en.wikipedia.org/wiki/Epoxy_resin), 2006.
5. Chemwatch, Material safety data sheet for Hexion Cellobond J2027L, 2005, pp. 1-14.  
Chemwatch, Material safety data sheet for Hexion Phencat 15, 2005, pp. 1-14.
6. Chemwatch, Material safety data sheet for Hexion Phencat 15, 2005, pp. 1-14.
7. Shackelford, J F, Introduction to Materials Science for Engineers, 3<sup>rd</sup> edition, Macmillan, 1992, pp.435-437, 459.

8. ISO 14125:1998(E), Fibre reinforced plastic composites – Determination of flexural properties.

9. Li, L, Dynamic Mechanical Analysis (DMA), Basics and Beyond, Perkin Elmer Inc. 2000, pp.3, 15, 17.

10. Crivello, J V, Sternstein, S S and Narayan, R, Mechanical characterization of glassfibre reinforced/UV cured resins from epoxidized linseed oil, Proceedings of the ASME Material division, ASME, 1995, MD-Vol. 69-1, 1995 IMECE, pp. 175-180.

11. Miyagawa, H, Mohanty, A K, Misra, M and Drzal, L T, Thermo-physical and impact properties of epoxy containing epoxidized linseed oil, 1anhydride-cured epoxy, Macromolecular materials engineering, 2004, Vol. 289, No. 7, pp. 629-635.

12. Yuan, X, Shao, M, Chen, M, Zhang, Y and Wang, J, Preparation and heat resistant characterization of phenolic resin modified by linseed oil, Journal of Jiangsu University (natural science edition), Vol. 27, No. 3, may 2006, pp. 234-236.

13. Yue, S, Hu, J, Huang, H, Fu, H, Zeng, H, Chen, H, Synthesis and application of phenolic resin internally toughened by chain extension polymer of epoxidized soybean oil, Journal of South China University of Technology (Natural Science), 2007, Vol. 35, No. 7, pp. 99-104.



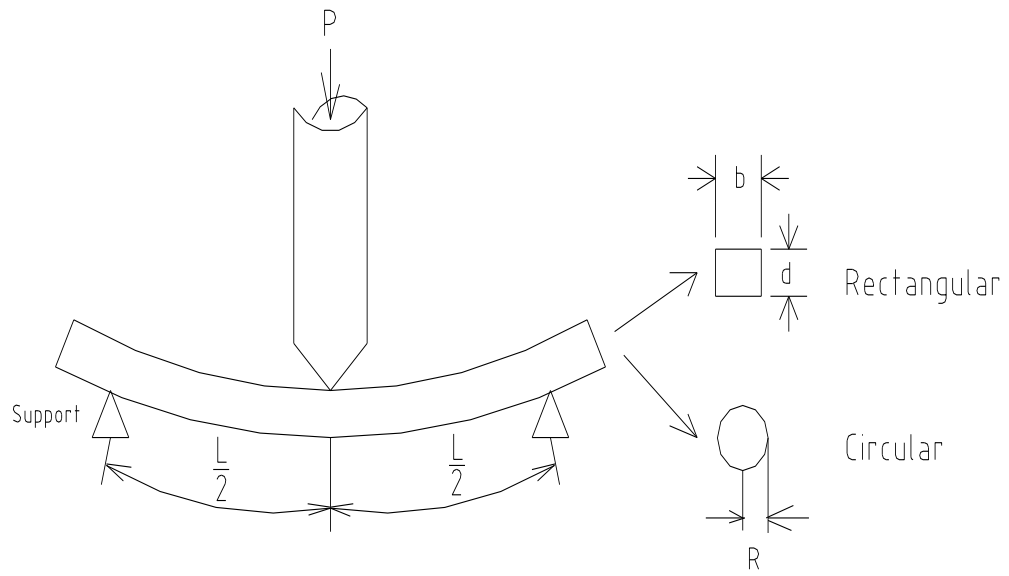
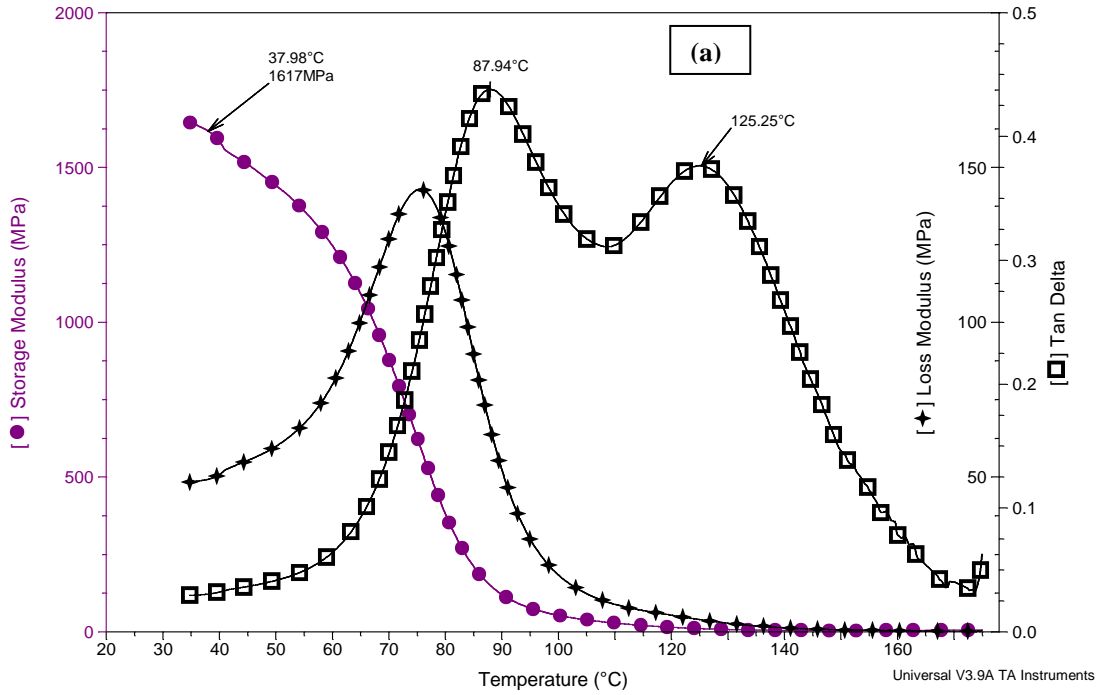

**Figure 1: A schematic diagram for three point bending test**

Sample: Sample 14  
 Size: 35.0000 x 10.8000 x 4.0400 mm  
 Method: Temperature Ramp  
 Comment: 50Epoxy-50Ph 6%pk15 4h60-4h100

DMA

File: C:\...1st tests\Sample 14.001  
 Operator: Francisco Cardona  
 Run Date: 18-May-06 17:18  
 Instrument: DMA Q800 V5.1 Build 92



Sample: Sample 16  
 Size: 35.0000 x 10.1800 x 4.0400 mm  
 Method: Temperature Ramp  
 Comment: 40%Epoxy-60%Ph 6%pk15 4h604h100

DMA

File: C:\...1st tests\Sample 16.001  
 Operator: Francisco Cardona  
 Run Date: 18-May-06 17:18  
 Instrument: DMA Q800 V5.1 Build 92

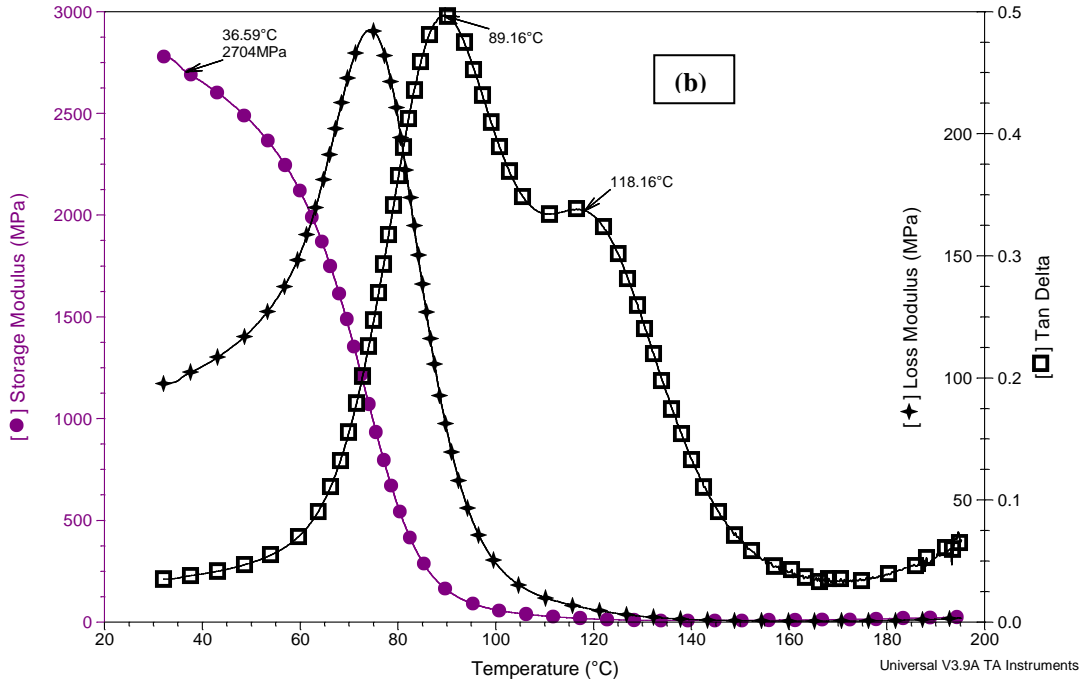
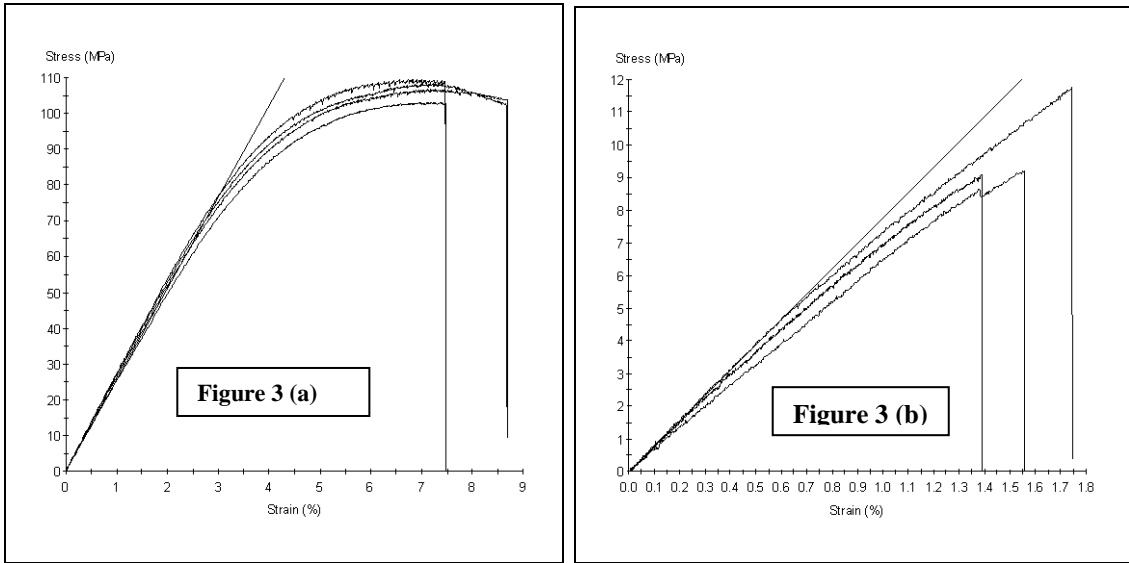

Figure 2: DMA results of composite 50/50 (a) and 40/60 (b) with 6% of phenacat 15 cured at ambient conditions for 4hours and then post-cured in an oven for 4 hours at 80°C and 4hours at 100°C



Figures 3: Flexural test results of HYREZ 202 (a) and of composite 80/20 (b)

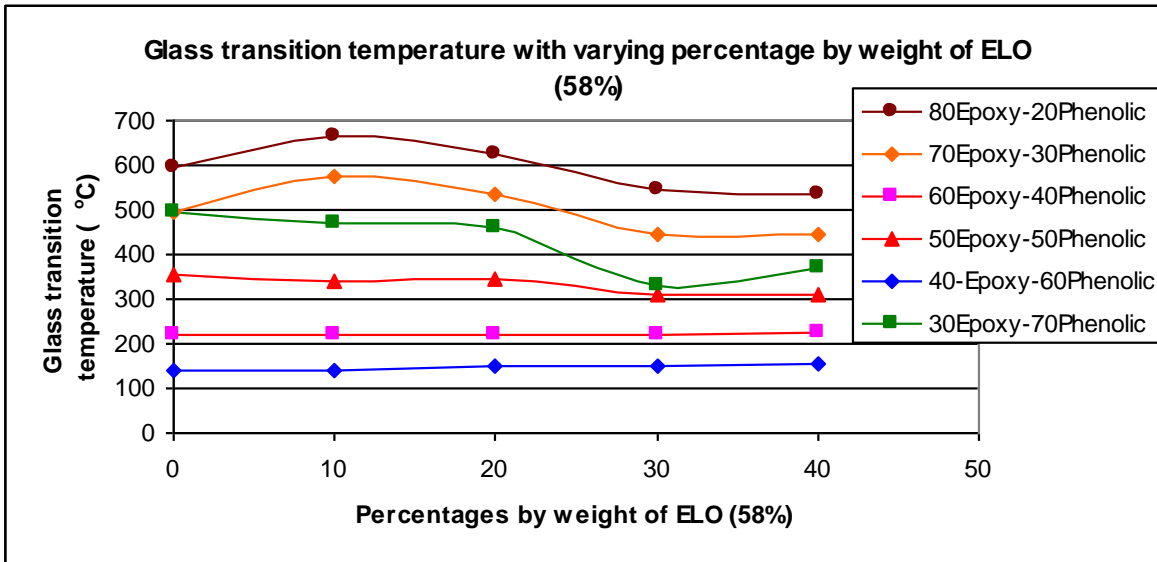

Figure 4: Glass transition temperature of epoxy and phenolic resins with varying ELO (58%)

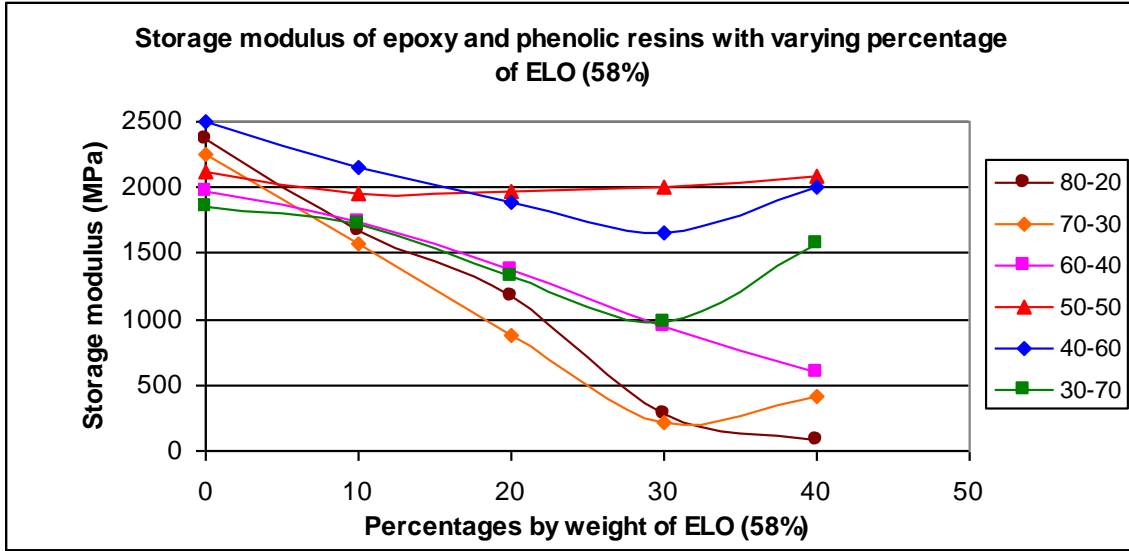

Figure 5: Storage modulus of epoxy and phenolic resins with varying percentages of ELO (58%)

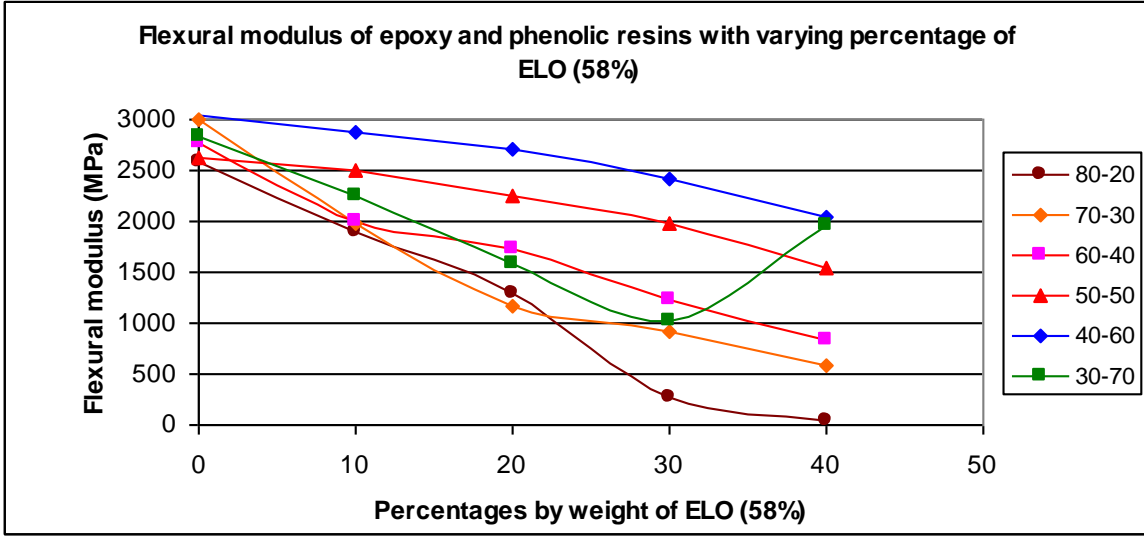

Figure 6: Flexural modulus of epoxy and phenolic resins with varying ELO (58%)

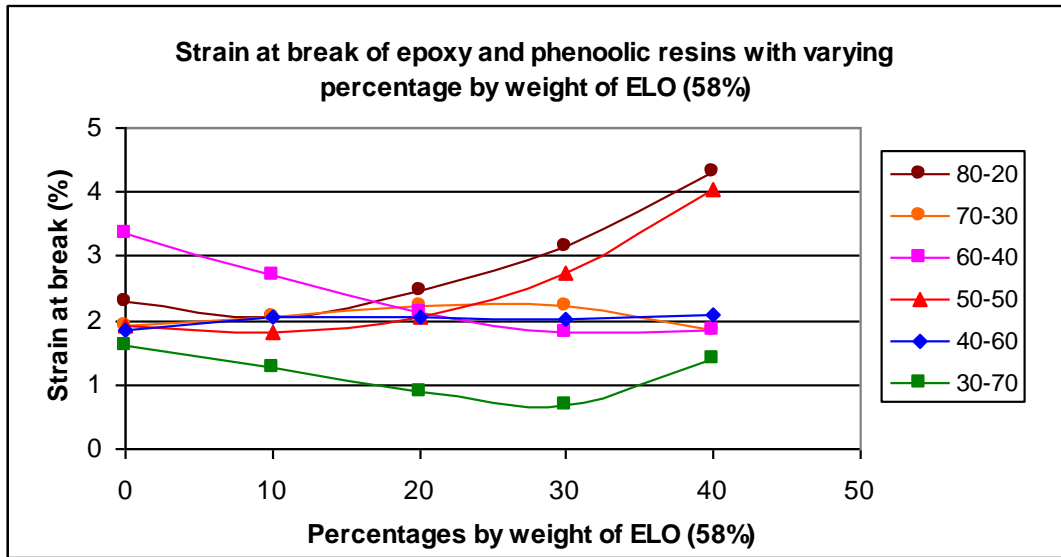

Figure 7: Strain at break (%) of epoxy and phenolic resins with varying ELO (58%)

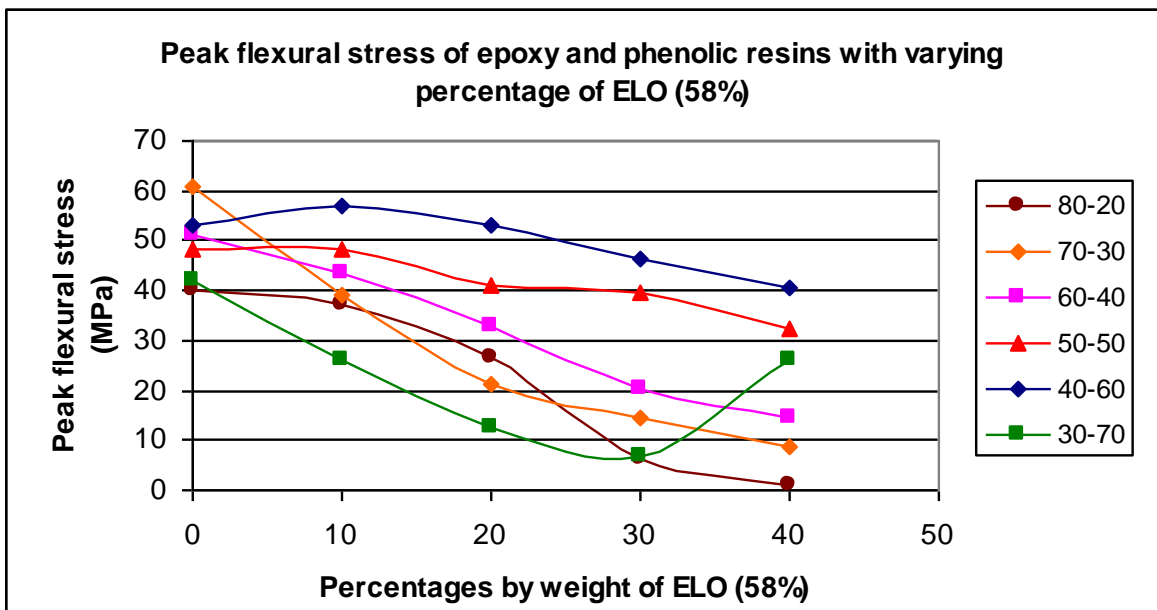

Figure 8: Peak flexural stress of epoxy and phenolic resins with varying ELO (58%)

**Table 1: Different percentage by weight of epoxy and phenol resins with linseed oil pre-mixed with epoxy resin**

Epoxy resin			Phenloic resin		Total mass of epoxy resin	Total mass of phenolic resin	Percentage Epoxidized linseed oil (58%) in phenolic resin	temperature and time of curing
Hyrez 202		Epoxidized linseed oil (58%)	Phenolic J2027L	5% Phencat 382				
Part A	Part B							
16	4	0	76	4	20	80	0	4h at 80 °C & ramp to 150 °C
14.4	4	1.6	76	4	20	80	10	ditto
12.8	4	3.2	76	4	20	80	20	ditto
11.2	4	4.8	76	4	20	80	30	ditto
9.6	4	6.4	76	4	20	80	40	ditto
24	6	0	66.5	3.5	30	70	0	ditto
21.6	6	2.4	66.5	3.5	30	70	10	ditto
19.2	6	4.8	66.5	3.5	30	70	20	ditto
16.8	6	7.2	66.5	3.5	30	70	30	ditto
14.4	6	9.6	66.5	3.5	30	70	40	ditto
32	8	0	57	3	40	60	0	ditto
28.8	8	3.2	57	3	40	60	10	ditto
25.6	8	6.4	57	3	40	60	20	ditto
22.4	8	9.6	57	3	40	60	30	ditto
19.2	8	12.8	57	3	40	60	40	ditto
40	10	0	47.5	2.5	50	50	0	ditto
36	10	4	47.5	2.5	50	50	10	ditto
32	10	8	47.5	2.5	50	50	20	ditto
28	10	12	47.5	2.5	50	50	30	ditto
24	10	16	47.5	2.5	50	50	40	ditto
48	12	0	38	2	60	40	0	ditto
43.2	12	4.8	38	2	60	40	10	ditto
38.4	12	9.6	38	2	60	40	20	ditto
33.6	12	14.4	38	2	60	40	30	ditto
28.8	12	19.2	38	2	60	40	40	ditto
56	14	0	28.5	1.5	70	30	0	ditto
50.4	14	5.6	28.5	1.5	70	30	10	ditto
44.8	14	11.2	28.5	1.5	70	30	20	ditto
39.2	14	16.8	28.5	1.5	70	30	30	ditto
33.6	14	22.4	28.5	1.5	70	30	40	ditto
64	16	0	19	1	80	20	0	ditto
57.6	16	6.4	19	1	80	20	10	ditto
51.2	16	12.8	19	1	80	20	20	ditto
44.8	16	19.2	19	1	80	20	30	ditto
38.4	16	25.6	19	1	80	20	40	ditto

**Table 2: Different percentage by weight of epoxy and phenol resins with linseed oil pre-mixed with phenolic resin**

Sample No.	Epoxy resin		Phenlic resin			Total mass of epoxy resin	Total mass of phenolic resin	Percentage Epoxidized linseed oil (58%) in phenolic resin	temperature and time of curing
	Hyrez 202		Epoxidized linseed oil (58%)	Phenolic J2027L	5% Phencat 382				
	Part A	Part B							
15-1	8	2	0	85.5	4.5	10	90	0	4h at 80°C & ramp to 150 °C
15-2	8	2	8.55	76.95	4.5	10	90	10	ditto
15-3	8	2	17.1	68.4	4.5	10	90	20	ditto
15-4	8	2	25.65	59.85	4.5	10	90	30	ditto
15-5	8	2	34.2	51.3	4.5	10	90	40	ditto
15-6	16	4	0	76	4	20	80	0	ditto
15-7	16	4	7.6	68.4	4	20	80	10	ditto
15-8	16	4	15.2	60.8	4	20	80	20	ditto
15-9	16	4	22.8	53.2	4	20	80	30	ditto
15-10	16	4	30.4	45.6	4	20	80	40	ditto
15-11	24	6	0	66.5	3.5	30	70	0	ditto
15-12	24	6	6.65	59.85	3.5	30	70	10	ditto
15-13	24	6	13.3	53.2	3.5	30	70	20	ditto
15-14	24	6	19.95	46.55	3.5	30	70	30	ditto
15-15	24	6	26.6	39.9	3.5	30	70	40	ditto
15-16	32	8	0	57	3	40	60	0	ditto
15-17	32	8	5.7	51.3	3	40	60	10	ditto
15-18	32	8	11.4	45.6	3	40	60	20	ditto
15-19	32	8	17.1	39.9	3	40	60	30	ditto
15-20	32	8	22.8	34.2	3	40	60	40	ditto
15-21	40	10	0	47.5	2.5	50	50	0	ditto
15-22	40	10	4.75	42.75	2.5	50	50	10	ditto
15-23	40	10	9.5	38	2.5	50	50	20	ditto
15-24	40	10	14.25	33.25	2.5	50	50	30	ditto
15-25	40	10	19	28.5	2.5	50	50	40	ditto
15-26	48	12	0	38	2	60	40	0	ditto
15-27	48	12	3.8	34.2	2	60	40	10	ditto
15-28	48	12	7.6	30.4	2	60	40	20	ditto
15-29	48	12	11.4	26.6	2	60	40	30	ditto
15-30	48	12	15.2	22.8	2	60	40	40	ditto
15-31	56	14	0	28.5	1.5	70	30	0	ditto
15-32	56	14	2.85	25.65	1.5	70	30	10	ditto
15-33	56	14	5.7	22.8	1.5	70	30	20	ditto
15-34	56	14	8.55	19.95	1.5	70	30	30	ditto
15-35	56	14	11.4	17.1	1.5	70	30	40	ditto
15-36	64	16	0	19	1	80	20	0	ditto
15-37	64	16	1.9	17.1	1	80	20	10	ditto
15-38	64	16	3.8	15.2	1	80	20	20	ditto
15-39	64	16	5.7	13.3	1	80	20	30	ditto
15-40	64	16	7.6	11.4	1	80	20	40	ditto

**Table 3: Results of ambient cured and ambient plus post-cured of the two resins.**

Sample No.	Hyrez 202 (percentage by weight)	Phenolic with 5% Phencat 382 (percentage by weight)	Ambient cured	Ambient plus oven cured
1	50	50	ok	ok
2	60	40	x	foam
3	70	30	x	foam
4	80	20	x	foam
5	100	0	ok	ok
6	40	60	ok	ok
7	30	70	too brittle	ok
8	20	80	x	bubbles
9	0	100	ok	bubbles