

ADEL MOTTAHEDI^{1*}, NAJ AZIZ¹, ALEX REMENNIKOV¹,
ALI MIRZAGHORBANALI², KEVIN MARSTON¹

IMPACT LOADING OF TENDON REINFORCEMENT SYSTEMS USED FOR GROUND CONTROL: A CRITICAL LITERATURE REVIEW

The present paper reports on various test methods and techniques which have been developed throughout the last decades. These methods have been used to evaluate both axial and shear performance of tendons under impact loading mode. Based on the literature review conducted on the scientific documents, published between 1992 and 2024, the developed facilities mainly work based on the direct impact and momentum transfer methods. In the direct impact method, which can be done in-situ and in the laboratory, the impact energy is applied by a mass freely falls to the test sample. In the momentum transfer method, the test assembly, consisting of both the mass and test sample free-fall at the beginning of the test until the movement of the assembly is halted by a stopper, and the momentum of the mass is transferred to the test sample. Besides, most of the current facilities are working based on the direct impact method. It was also found that less research have been conducted on dynamic shear testing, especially high-strength cable bolts, as most of the facilities have been designed for pull testing. In addition, it was found that in dynamic pull-out tests of rock bolts, two main mechanisms of energy absorption are identified: steel plastic deformation and bolt sliding within the encapsulation medium. The first impact plays a key role in energy absorption, causing significant permanent displacements, while the energy consumed in displacing the bolt is more indicative of dynamic behavior than the total input energy. According to the results, the tendons that undergo static deformations before dynamic loading are more prone to failure as some parts of their performance have already lost. Meanwhile, differences between dynamic and static shear tests suggest that dynamic tests require less energy for failure, as friction is ineffective in impact loading. Finally, the study highlights gaps in the current understanding of tendon performance under impact loading, with potential research directions aimed at improving safety in underground excavation.

Keywords: Rock reinforcement; Impact loading; pull-out test; shear strength; cable bolt; ground seismicity

¹ UNIVERSITY OF WOLLONGONG, SCHOOL OF CIVIL, MINING, AND ENVIRONMENTAL ENGINEERING, WOLLONGONG, AUSTRALIA

² UNIVERSITY OF SOUTHERN QUEENSLAND, SCHOOL OF CIVIL ENGINEERING AND SURVEYING, TOOWOOMBA, AUSTRALIA

* Corresponding author: am3887@uowmail.edu.au

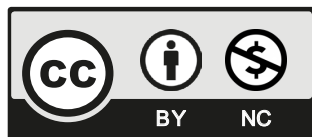

© 2024. The Author(s). This is an open-access article distributed under the terms of the Creative Commons Attribution-NonCommercial License (CC BY-NC 4.0, <https://creativecommons.org/licenses/by-nc/4.0/deed.en>) which permits the use, redistribution of the material in any medium or format, transforming and building upon the material, provided that the article is properly cited, the use is noncommercial, and no modifications or adaptations are made.

1. Introduction

Since the idea of rock reinforcement theory has been introduced by Lang [1], tendon reinforcement systems (generally cable bolts and rock bolts) have been widely used as an economical and an effective means of ground stabilisation. Generally, installed tendons are under tensile loading, shear loading, and the combination of both [2]. The axial and shear performance of tendons under static loading condition, representing the long-term ground settlements, during which no impact load is applied on tendons (i.e., zero acceleration) [3]. However, it is obvious that tendons are also susceptible to sustain dynamic loads, especially in those underground structures struggling with the catastrophic ground seismic activities [4-6]. Seismic source events such as rock burst, coal burst, large-scale rock blasting practices, and shear zones slippage are able to release a huge amount of energy in a fraction of second [7-9]. Impact loading can cause high stress loading in tendons, resulting in tendon steel yielding, tendon anchorage loosening, and maybe tendon complete failure [10]. This impact load is highly likely to adversely affect Load Transfer Capacity (LTC) of tendons installed in the dynamically active zones; and consequently, it can jeopardize the stability and safety of the underground space. Therefore, it is highly necessary to study the mechanical behaviors of tendons not only under quasi-static loading mode, but also under impact loading condition.

As shown in Fig. 1a, the rock ejection is a potential event when a seismic wave encounters the underground excavation boundary. Generally, it depends on the scale of the seismic events, the seismic wave energy, and the rock mass condition (e.g., the level of stored strain energy, rock properties, and its fracturing degree) [11]. The ejected rock fragments can reach velocities between 3 and 10 m/s with corresponding energy levels varying from 10 to 50 kJ/m² [12]. In underground structures, when seismic loading starts, the role of the installed rock reinforcement system is to control the rock mass behaviour after the failure, whether this system is dynamic or non-dynamic capable. Thus, it cannot eliminate the failure caused by the dynamic loading [7,11,13]. Fig. 1b shows some examples of the severe consequences of the seismic loading in underground excavations. According to Cai [7], when it comes to impact loading, the rock reinforcement system not only must be able to absorb the impact energy, but also must be able to accommodate the large rock displacement after the rock failure. It means that to achieve dynamic

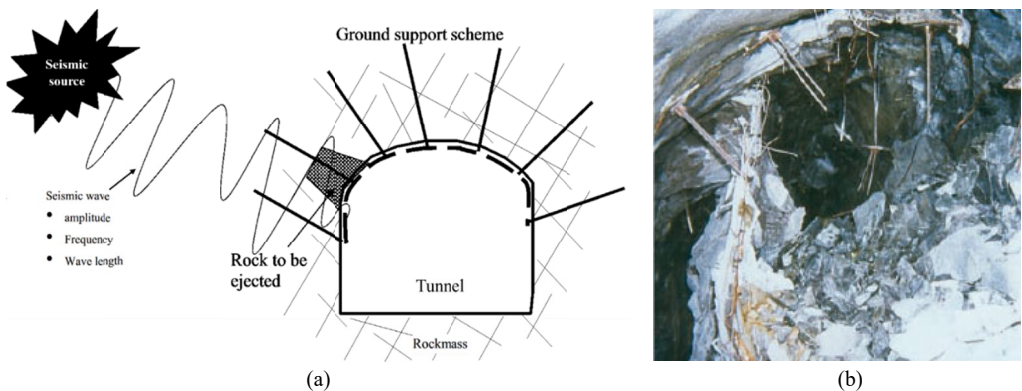

Fig. 1. (a) Tendon failure under impact loading [16] and (b) an impact loading damage [17]

equilibrium during the rock deformation process, the reinforcement system must allow the rock mass displacement in a controlled manner. Hence, to cope with seismic loading, there is a need to the flexible rock reinforcement systems, having enough displacement and load bearing capacities [7,14]. The tendon's ability to convert impact energy to strain energy (i.e., plastic yielding of tendon) determines their capacity of energy absorption [15].

Generally, the performance of a tendon under impact loads is explained in terms of impact velocity and kinetic energy input [18]. Throughout the last decades, different dynamic testing rigs has been developed to examine the rock reinforcement system's performance and capacity under seismic loading [5]. The developed rigs mainly employed two options to apply the dynamic load on the test sample as follow [5,12,15,18-20]:

- Direct impact principle, including *drop weight* and *swing weight* methods,
- Momentum transfer principle.

The direct impact method can be employed for both laboratory and in-situ tests [21]. In the drop weight method, the impact energy is applied by a mass freely falls to the test sample. On the other hand, in the swing weight method, an impact pendulum, which is raised to a specific angle, can be used to transfer the kinetic energy to the specimen. In the momentum transfer principle, test assembly, consisting of both the mass and test sample free-fall at the beginning of the test until the movement of the assembly is halted by a stopper, and the momentum of the mass is transferred to the test sample. Generally, in drop weight and momentum transfer methods, the initial impact velocity of the dropping weight or the test assembly can be estimated using the energy conservation law. Utilizing this law, the velocity can be estimated as follow [19]:

$$v_0 = \sqrt{2gH} \quad (1)$$

Where v_0 is the initial impact velocity (m/s), g is the gravitational acceleration constant (m/s^2), and H is the drop height (m). Therefore, the impact velocity, directly influencing the impact energy, can be controlled by the drop height. The total kinetic energy applied at the impact (E_0) can be calculated as follow [22,23]:

$$E_0 = \frac{1}{2}(mv_0^2) \quad (2)$$

Where m is the mass of dropping weight (kg) impact velocity. However, all dynamic testing facilities have energy loss and the above equation may incorrectly determine the energy transferred to the reinforcement system [22]. Thus, it should be noted that some parts of the energy might be taken out by the test rig's components. The absorbed energy (E_{SD}) by the tendon can be estimated by integrating the area underneath the dynamic load-displacement plot [24]:

$$E_{SD} = \int_0^l Fdl \quad (3)$$

Where l and F refers to displacement and load, respectively. It is worth mentioning that since the applied momentum in the dynamic test causes massive deformation and destruction of the sample, the assumption of inelastic momentum can be considered. For inelastic momentum, it is assumed that the impacting hammer (m_1) and the impacted sample (m_2) will move together with

a new velocity (v_u). Thus, the initial applied velocity on the sample (v_u) which is a proportion of v_0 can be determined based on principle of the momentum conservation as follow [25,26]:

$$v_u = v_0 \left(\frac{m_1}{m_1 + m_2} \right) \tag{4}$$

As can be seen in TABLE 1, most of the impact test facilities developed over the last decades are laboratory-based and a few of them have been designed for conducting in-situ tests. In addition, the weight of the falling object among the different test set-ups ranges between 11 to 20,000 kg. The highest possible height of free-fall has been 6 m. As shown in Fig. 2, in the case of laboratory methods, the majority of the developed testing facilities only allow to conduct impact pull-out tests. However, since 2010s, the impact shear testing of tendons has also been undertaken. Moreover, it is shown that, expect a few testing rigs, most of them have been only used for impact testing of rock bolts. It is also clear that, in the developed rigs, the drop weight principle has been the dominant method for applying the impact load onto the samples. In the following, the test facilities proposed for impact testing of tendons have been critically reviewed and the tendon’s performance under impact loading have been investigated to enhance the current understating of this topic and to find the future research directions.

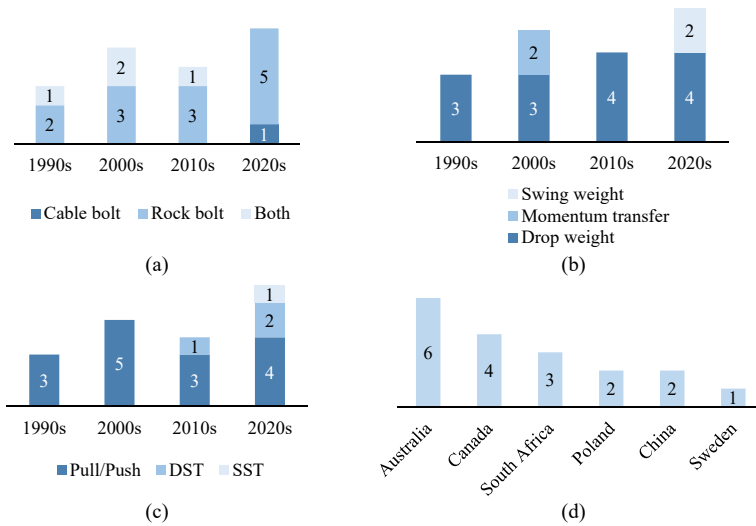

Fig. 2. The frequency of the developed impact test rigs based on the (a) type of tendon, (b) loading option, (c) test type, country of origin

2. Impact Test Facilities of Tendon Reinforcement Systems

2.1. Axial Loading Mode

Yan [27] reported an impact test rig developed at the University of British Columbia. As shown in Fig. 3a and b, the test set-up worked based on the drop weight principle and allowed

TABLE 1

The developed rigs for impact testing of tendons

Ref.	Year	Test Type	Test Method	Loading Option	Max. Mass (kg)	Max. Drop Height (m)	Max. Impact Velocity (m/s)	Max. Impact Energy (kJ)	Tendon Type
Yan [27]	1992	Push/pull-out	Laboratory	Drop weight	505	4	N/A	N/A	Rock bolt
Yi and Kaiser [28]	1994	Pull-out	Laboratory	Drop weight	48.49	0.3	2.43	0.14	Rock bolt
Ortlepp and Stacey [29]	1998	Pull-out	Laboratory	Drop weight	2706	4	20	N/A	Cable/rock bolt
Ansell [15]	2000	Pull-out	Laboratory	Momentum transfer	219	5.1	12	0.16	Rock bolt
Gaudreau et al. (2004) [30]	2004	Pull-out	Laboratory	Drop weight	1000	2	6.3	20	Rock bolt
Player et al. [22]	2004	Pull-out	Laboratory	Momentum transfer	4500	6	10	225	Cable/rock bolt
Ortlepp and Erasmus [31]	2005	Pull-out	Laboratory	Drop weight	10,000	4	8.9	390	Cable/rock bolt
Plouffe et al. [16]	2008	Pull-out	Laboratory	Drop weight	3000	2	6.26	58.86	Rock bolt
Carlton et al. [32]	2013	Pull-out	In-situ	Drop weight	890	2.1	6.5	18.8	Cable/rock bolt
L [33]	2016	Double Shear	Laboratory	Drop weight	185	3	7.67	5.44	Rock bolt
Pytlík [25]	2016	Pull-out	Laboratory	Drop weight	20,000	0.12	1.2	14.4	Rock bolt
Crompton et al. [34]	2018	Pull-out	Laboratory	Drop weight	3171	2.1	6.42	65	Rock bolt
Aziz et al. [35]	2020	Double Shear	Laboratory	Drop weight	592	4.2	8.85	23.50	Rock bolt
Pytlík [36]	2020	Single Shear	Laboratory	Drop weight	2429	0.2	2	4.85	Rock bolt
Darlington et al. [23]	2023	Pull-out	In-situ	Drop weight	2000	1.7	5.6	28.3	Rock bolt
Anzanpour et al. [37]	2023	Pull-out	Laboratory	Drop weight	592	4.2	8.85	23.50	Cable bolt
Wang et al. [38]	2023	Pull-out	Laboratory	Swing weight	11	N/A	N/A	N/A	Rock bolt
Kang et al. [20]	2024	Pull-out	Laboratory	Swing weight	N/A	N/A	N/A	10	Rock bolt

both push-out and pull-out tests by removing and adding the anvil support with a stiffness 15 times that of the steel bar. In this rig, a 345 kg hammer dropped from a 2.4 m height and transferred the energy to the test sample. To increase the impact energy, the weight of the hammer was later increased to 505 kg. Meanwhile, the dropping height could be altered up to 4 m. The test specimen allowed static testing, making it possible to compare the results in different loading modes. However, the very short encapsulation length (about 63.5 cm) of the steel bar is the main issue with this study. Later, Yi and Kaiser [28] reported the GRC weight drop rig for impact testing of 6.35-mm and 15.88-mm diameter steel rods with cushions. The GRC rig worked based on the drop weight method and was used to demonstrate the effect of multiple impact loading. This kind of loading can lead to plastic strain accumulation on the rock bolt. The set-up of GRC is shown in Fig. 3c. Although it was simple and affordable, it was a small-scale rig limiting the dropping height and weight to relatively small values.

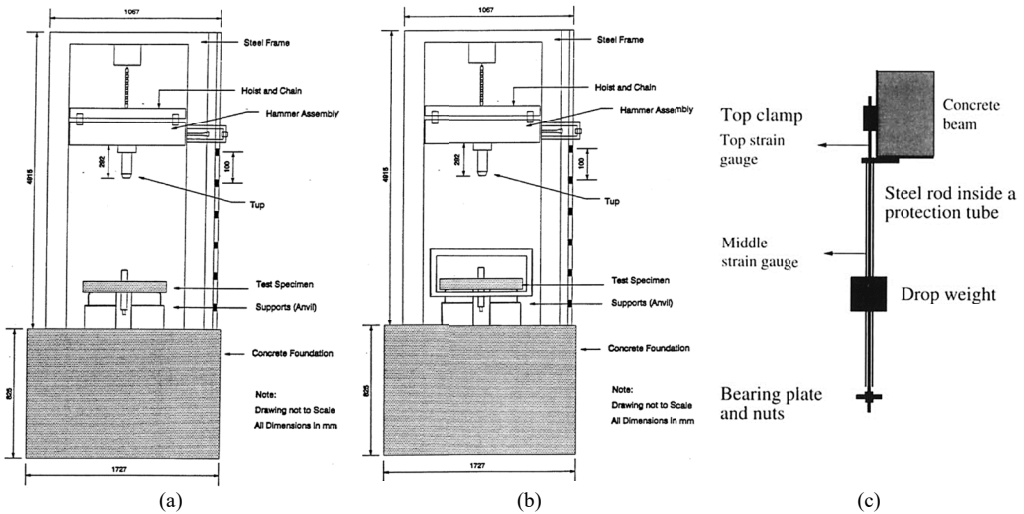

Fig. 3. The drop weight impact test machine for (a) push-out test and (b) pull-out test [27], and (c) the GRC weight drop rig [28]

The Steffen Robertson and Kirsten Consultants (SRK) developed a drop weight test rig which was reported by Ortlepp and Stacey [39]. The first version of this rig was able to apply 70 kJ of impact energy with impact velocity up to 8.8 m/s (see Fig. 4a). However, it was only used for dynamic testing of the surface support systems including wire mesh, lacing, and shotcrete. Later, the SRK set-up #1 was modified in a way to be able to conduct dynamic tensile test of tendons encapsulated into steel tubes. The new version, called SRK set-up #2, was reported by Ortlepp and Stacey [29] as it is shown in Fig. 4b. The modified rig was employed for testing various kinds of tendons (e.g., 18-mm cable bolts and Swellex bolts). As shown, when the dropping weight impacts the stationary “swing beam”, the impact energy transferred to the outside of steel pipe wall and the head of the bolt, representing the load applied by the ejected rock to the borehole and grout annulus. The rig could apply 80 kJ of impact energy utilizing a dropping mass. The length of embedment range from 600 mm (for rigid bolts) to 2400 mm (for friction

bolts). Even though SRK set-up #2 was relatively affordable, there were some limitations in the system instrumentation. There was no load cells for recording the bolt's load. Displacement and failure were also investigated by photos taken before and after the test. Meanwhile, the energy loss due to the support and swing beams deflection was not measured.

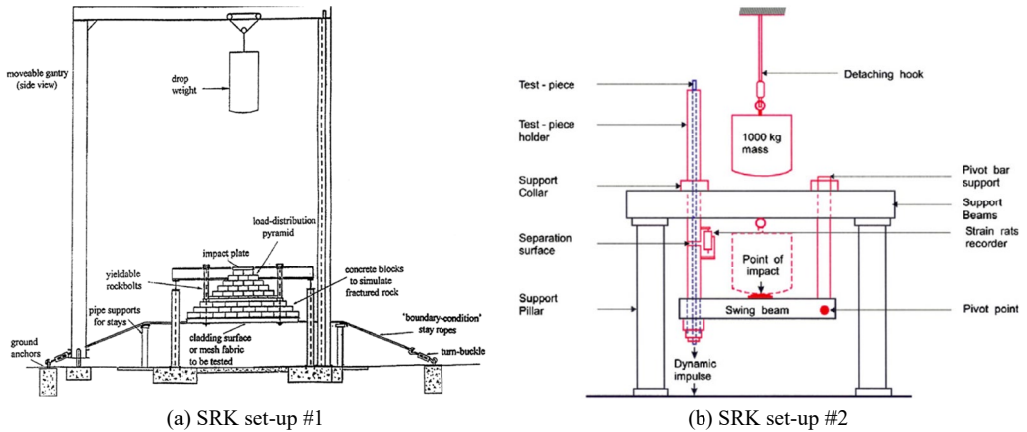

Fig. 4. The general views of the impact testing facilities, adapted from [29,39]

Ansell [15] reported a set-up, developed at the Royal institute of Technology in Stockholm, for dynamic testing of fully grouted rock bolts. Since a heavy dropping weight provides a number of problems for the set-up, they decided to use a free falling test specimen, involving the 16-mm smooth rock bolt cast in a 150-mm steel cylinder (111 kg of drop mass) and 200-mm steel cylinder (219 kg of drop mass). Thus, the test rig worked based on the momentum transfer principle. Fig. 5a shows the test set-up. As can be seen, the movement of the test sample is stopped by dropping the 1.5-m long beam, attached to the bolt's nut, on the two parallel beams with H-shaped cross-sections. Such a collision between these parts could result in energy loss as they could absorb a proportion of the impact load. This loss of energy was not measured in this study and the total energy transferred to the bolt was different from the theoretical estimations. Thus the rig was not able to replicate the real ejection mechanism. Next, Gaudreau et al. [30] reported the Noranda Technology Center (NTC) impact test rig which was developed for testing modified con bolts up to 1.7 m long. As shown in Fig. 5b, in this dynamic test, a mass of 1000 kg was dropped from the maximum height of 2 m on the test sample. However, the application of greater drop weight and height was not allowed due the rig structure. Moreover, during the tests, the bolts failed before being pulled out, which negatively affect the successfulness of the tests.

In another research, Player et al. [22] reported the dynamic test rig developed at the Western Australia School of Mine (WASM). As shown in Fig. 6a, the rig was built based on the momentum transfer method and includes three main components:

- The reinforcement system includes the bolt and surface hardware (plate).
- The simulated ejected rock includes the collar zone, lower pipe length and steel rings.
- The simulated rock mass includes the anchor zone, upper pipe length and the drop beam.

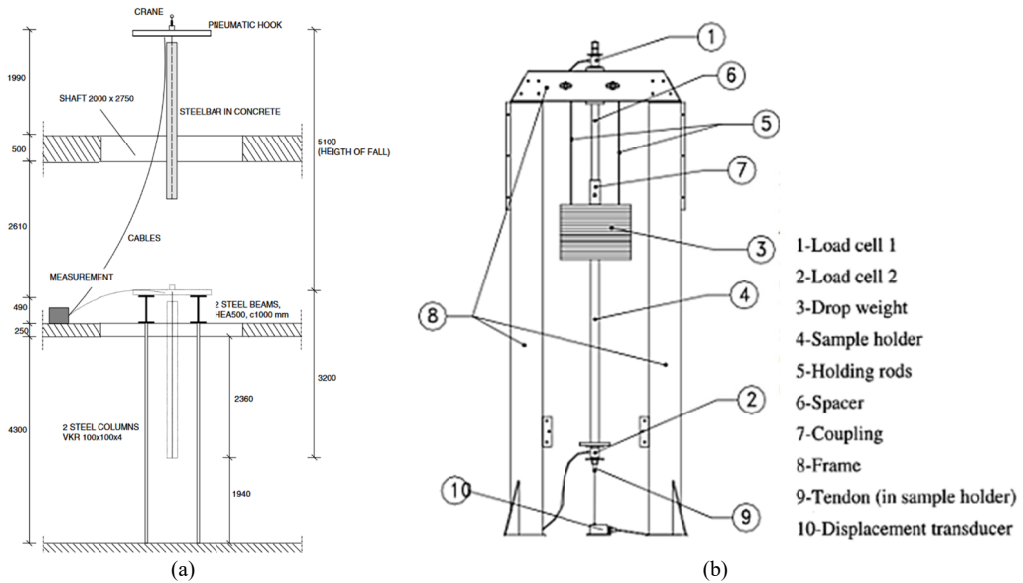

Fig. 5. (a) Test rig for impact testing of fully grouted rock bolts, adapted from [15,19] and (b) The NTC impact test set-up for impact testing of tendons [30]

When all three components are dropped as a one unit, they will fall at an equal velocity, representing the energy transferring through the rock mass before the seismic event occurs (e.g., a rock burst). Thus, the free falling part was a simulated rock mass reinforced by a tendon up to 2.4 m long. Then, this part with mass of 4500 kg could be dropped at an ultimate velocity of 10 m/s onto hydraulic buffers (i.e., impact surface), applying an impact energy up to 225 kJ. The WASM rig was well instrumented, and it allowed calculation of the energy absorbed by the different parts of the rig. However, at velocities more than 7 m/s, the buffers damaged. Thus, the results were adversely affected by the stiffness of the buffers. To simulate the borehole, the cable was installed in a steel tube, which overestimated the obtained results. Another issue is that the impact duration was about 140 ms, appearing longer and thus decreasing the dynamic aspect of the test. In addition, since the test assembly was fallen then rapidly slowed by the buffers, the energy absorbed by the reinforcement system was different from what was involved in the test.

Ortlepp and Erasmus [31] reported the SRK/Duraset wedge-block loading device, which is a displacement conversion device. This rig allows to test cables and rock bolts longer than 5 m long as the test sample can be placed horizontally. As shown in Fig. 6b and c, the tendon is encapsulated in a steel hollow bar called specimen holder. This holder is passed through guided thrust blocks with inclined faces and the middle wedge (see Fig. 6b). Once the drop weight with mass of 10,000 kg impacts the middle wedge, it drives the guided blocks apart, converting the vertical movement into horizontal movement (see Fig. 6c). In this research, 1.2 m tendons were used, and the maximum drop height was 4 m, which resulted in 390 kJ impact energy at the ultimate velocity of 8.9 m/s. However, limited test results are available about this apparatus and the steel tube could overestimate the results.

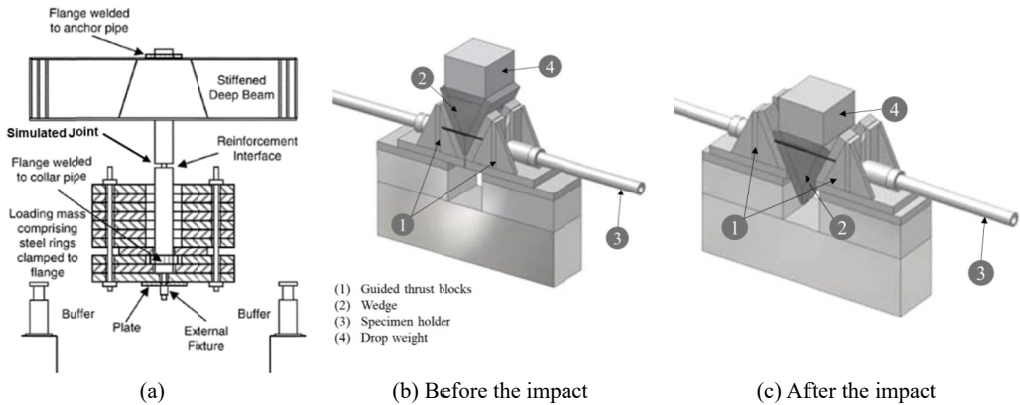

Fig. 6. (a) the WASM impact test rig, adapted from [22,11], (b) and (c) the SRK/Duraset wedge-block loading device, adapted from [31]

Plouffe et al. [16] modified the NTC rig at the Canada Centre for Mineral and Energy Technology (CANMET) and Mining and Mineral Sciences Laboratory (MMSL). The CANMET-MMSL test rig is illustrated in Fig. 7a. As shown, the bolts up to 2.1 m long is encapsulated in a steel tube with inside and outside diameters of 38 mm and 47.5 mm, respectively. Then, a mass of 3000 kg is dropped from the maximum height of 2 m onto the impact plate, applying around 60 kJ kinetic energy to the test sample. The weight drops are repeated until the rockbolt fails or a predetermined energy is absorbed. In this study, the plate and the bolt end displacements were collected utilizing Dalsa SP-14-02K40 line scan cameras, sampling at 10,000 lines/s to match the sampling of the analogue signals. The top piezoelectric load cells measured the load transferred to the test structure and the bottom load cells measured the load applied to the bolt

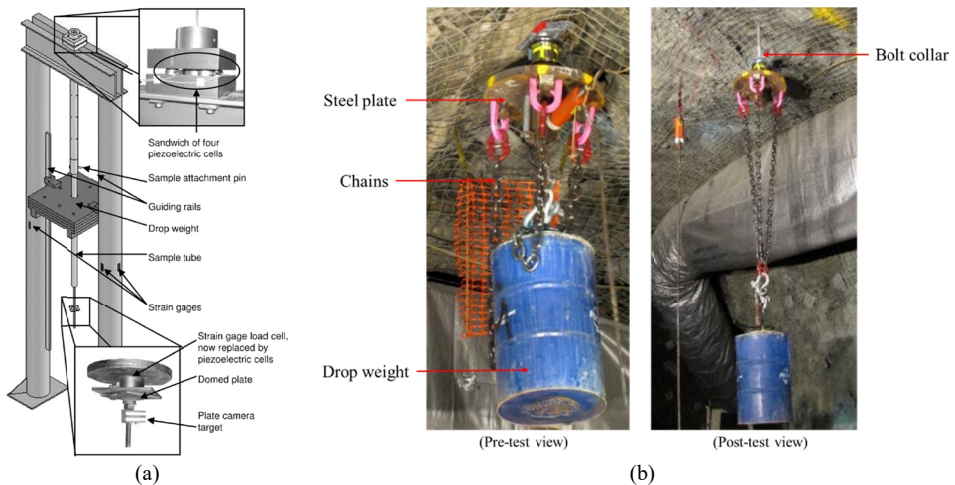

Fig. 7. (a) the CANMET-MMSL test rig, adapted from [16,12] and (b) the pre-test and post-test views of the Rocktech Mt Charlotte drop test rig, adapted from [32]

and plate. Additionally, to measure the tensile stress and detect bending of both columns of the test rig, three strain gages were attached on them separated by 90°. The test rig is equipped with two piezoelectric load cells measuring the force applied to the bolt. There are some issues with this set-up. It should be noted that the rig employed steel confinement, overestimating the results. Meanwhile, the energy losses were not accounted during the experiments. In another research, Carlton et al. [32] reported the Rocktech Mt Charlotte drop test rig which is able to drop a mass of 890 kg from a height of 2.1 m, resulting in 18.8 kJ impact energy at the velocity of 6.5 m/s. In this method, as can be seen from Fig. 7b, the loading system involves a 700-mm diameter 40-mm thick steel plate attached to three chains with capacity of 150 kN. These chains are connected to the drop weight. In this study, a high-speed video camera was used to record the bolt displacement versus time. However, the test set-up is only suitable for in-situ dynamic tests.

Pytlik [25] reported the dynamic test methodology developed at the Central Mining Institute (GIG) for testing rock bolts. As shown in Fig. 8a, in the proposed rig, the 400-mm long of the rock bolt anchored in a steel cylinder and is dynamically loaded using a free-fall mass of up to 20,000 kg. The height of fall is between 0.01 to 0.12 m. Therefore, around 14.4 kJ of kinetic energy is applied onto the test sample at the maximum velocity of impact was 1.2 m/s. As can be seen, first, the drop weight impacts the traverse. Then, using the load transfer shafts, the impact load is applied onto the sample. In this study, a portion of the kinetic energy of the free-falling mass lost to set the traverse in motion. In addition, the structure of the test rig allows both static and dynamic testing of rock bolts. Hence, it is possible to make a comparison between the tests' outcomes. Crompton et al. [34] reported the New Concept Mining (NCM) dynamic impact tester (DIT) rig allowing both single and double embedment pull testing of bolts up to 3.5 m long (see Fig. 8b). Using this rig, a mass of 3171 kg dropped at the maximum velocity of 6.42 from the height of 2.1 m onto the test sample. Thus, the maximum impact energy could be 65 kJ. However, the tested bolt was encapsulated within the steel pipe, overestimating the results.

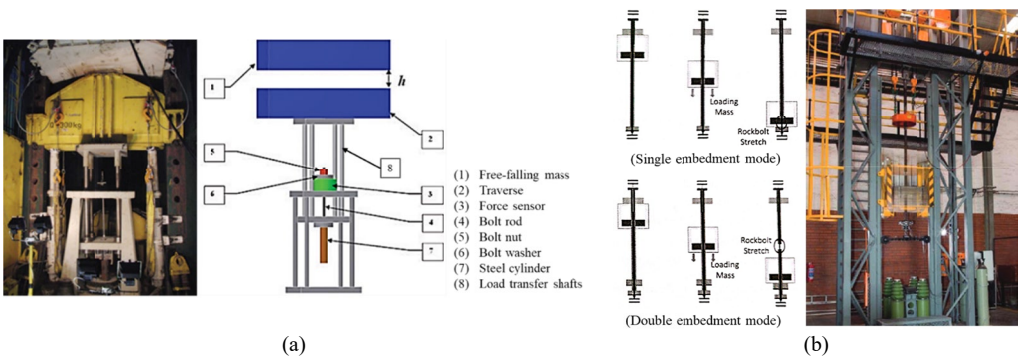

Fig. 8. (a) the GIG impact test facility, adapted from [25] and (b) the NCM's DIT rig, adapted from [34]

Anzanpour et al. [37] used the impact drop hammer rig and Reverse Pull-out Test Machine (RPTM) developed at the University of Wollongong as shown Fig. 9a. The dropping hammer (592 kg), which can be fallen from a height up to 4.2 m, provides an ultimate impact velocity of

8.85 m/s, resulting in 23.50 kJ kinetic energy. In this research, 300 mm of the cable bolt length was encapsulated in a concrete sample, which can be internally and externally confined by steel tubes. It is worth mentioning that it is possible to perform both static and impact tests using RPTM. However, in the impact pull tests, since the installed load cell on the cable was not able to record the loads accurately due to the limitation of calibration, the measurement of the impact energy was done by the load cell attached on the tup, which did not represent the accurate applied load on the cable due to the energy losses in the rig components. Therefore, either the instrumentation of the rig can be enhanced to measure these energy dissipations, or a more reliable load cell can be installed on the cable. Later, Darlington et al. [23] reported a test rig developed by Sandvik for performing in-situ impact tests. As shown in Fig. 9b, it is a portable apparatus which allows different drop weight and drop height to change the impact energy. The length of the drop rod, which transfers the load to the bolt, is over 1.7 m and the drop weight can be up to 2000 kg. The claw allows connection of mass to the rock bolt. It contains the load cell and accelerometer for measuring the load and displacement. It is worth mentioning that the domed surface facilitates testing of non-vertically installed rock bolts (up to 10° from vertical).

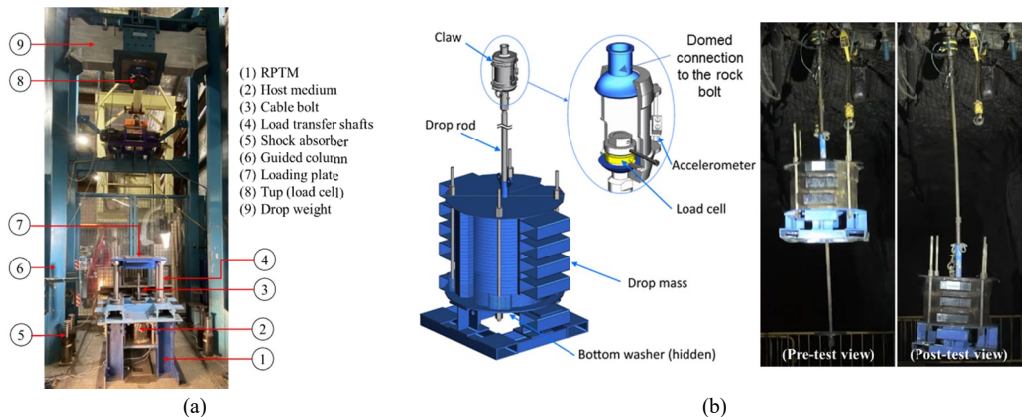

Fig. 9. (a) the impact pull-out test set-up, adapted from [37] and (b) the Sandvik in-situ impact test rig, adapted from [23]

Wang et al. [38] introduced a dynamic loading device working based on the swing weight method. As shown in Fig. 10a, a swing hammer up to 11 kg impacts the 18-mm rock bolt encapsulated in a large concrete block. In this study, 1.8-m long rock bolts were used, and the length of encapsulation was 1.6 m. However, the scale of the test set-up is small, limiting the amount of impact energy and the size of the tested tendons. In another study, Kang et al. [20] used the swing weight method and applied up to 10 kJ impact energy to the impact beam connected to the 22-mm rock bolt encapsulated in a 120-mm concrete cylinder with 1 m long (Fig. 10b). It should be noted that, before applying the impact load, the bolt is pre-tensioned to a specific value. In addition, after applying the dynamic load, the bolt is statically pulled out until it fails in tension. Therefore, in this test, the bolt is under the pretension-impact-pull condition. The test set-up allows both static and dynamic pull-out testing of rock bolts. However, the amount of the impact load applied on the test sample is limited by the set-up scale.

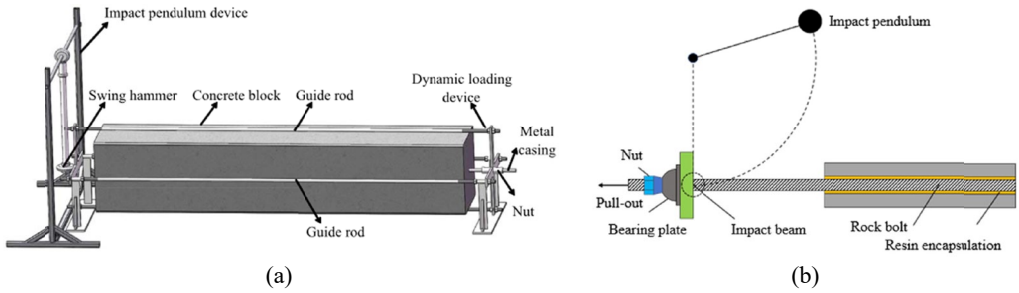

Fig. 10. The swing hammer test set-ups: (a) [38] and (b) [20]

2.2. Shear Loading Mode

Li [33] employed a drop test, developed at the University of Technology Sydney, for impact double shear testing of 8-mm and 16-mm diameter rock bolts. As shown in Fig. 11a, the apparatus is able to drop an ultimate mass of 185 kg from a height up to 3 m, resulting in maximum drop velocity and impact energy of 7.67 m/s and 5.44 kJ, respectively. In this study, utilizing the drop test rig, the influence of different parameters like angel of inclination, bolt diameter, and the initial impact velocity on the dynamic shear performance of rock bolts were investigated. Since it is possible to perform static tests using the double shear box, the results of the impact and static tests can be compared. However, the size of the rig was not sufficient enough to test larger diameter bolts to fail. Next, Aziz et al. [35] conducted double shear test under impact loading by utilizing the impact drop hammer rig. In this study, a small-scale double shear box, called MK-I, was used (Fig. 11b). In this study, the host medium were internally confined, enhancing the integrity of the test sample during the tests. However, only small-diameter rock bolts were tested, and the weight of the drop hammer was no sufficient for impact testing of high-capacity tendons.

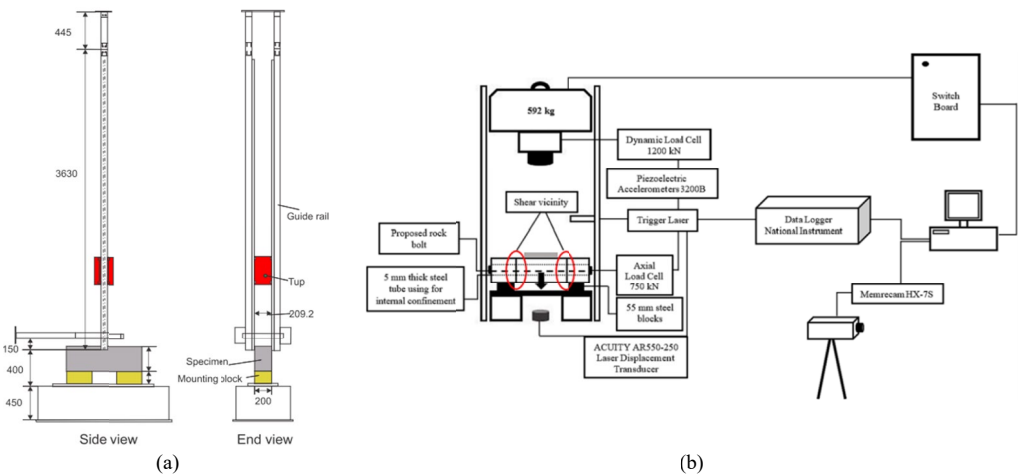

Fig. 11. (a) the schematic view of the drop test rig, adapted from [26,33] and (b) the impact shear test set-up using drop hammer rig, adapted from [24,35]

Pytlik [36] carried out relatively simple and repeatable tests by employing the single shear impact test rig shown in Fig. 12. In this research, the impact mass of 2429 kg was fallen from a height of 0.2 m, resulting in a maximum impact velocity of 2 m/s. The test arrangement allowed both static and dynamic tests, providing a comparison between the results. In spite of all benefits, the single shear rig was a guillotine-type device, which may not represent the real field condition, and underestimate the bolt shear resistance. Besides, only testing of rock bolts were allowed.

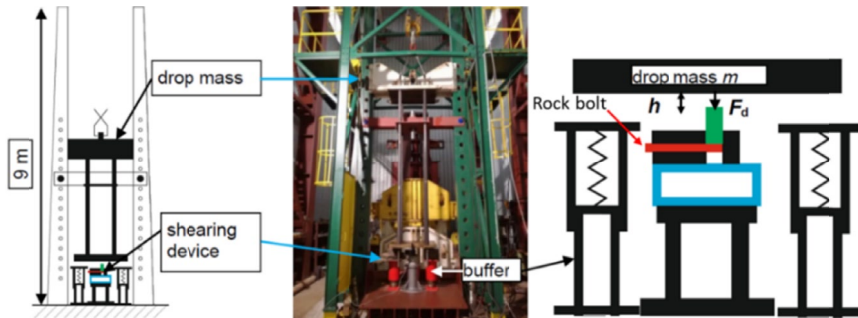

Fig. 12. The single shear impact test rig [36]

Based on the reviewed test facilities, their benefits and limitations, which can affect their applicability, are summarized in TABLE 2.

TABLE 2

The benefits and limitations of the impact test rigs

Ref.	Rig's Name	Advantage(s)	Limitation(s)
1	2	3	4
Yan [27]	Impact Drop Test Rig	Allowing pull and push testing. The test assembly allows both static and impact loading, making it possible to compare the results of different loading modes. Concrete block is used as the host medium.	Very short encapsulation length of the bolt. The test rig scale only allows testing of small-diameter bolts. Only rock bolts were tested.
Yi and Kaiser [28]	GRC Weight Drop Rig	Allowing multiple drops.	Low impact energy due to the limited drop height and weight. So, small-diameter bolts were tested. The impact velocity is not enough to replicate the ejected rock velocity. The tendon is directly encapsulated inside the steel cylinder, may overestimating the host medium strength. Only rock bolts were tested.

TABLE 2. Continued

1	2	3	4
Ortlepp and Stacey [29]	SRK Set-up #2	<p>It is able to test various types of tendons, including cable bolts. Allowing large length of encapsulation.</p> <p>It is possible to test tendon using double embedment configuration.</p>	<p>The system instrumentation for monitoring the loads and displacement was limited. Thus, measuring the energy dissipation due to the rig's part was difficult.</p> <p>The tendon is directly encapsulated inside the steel cylinder, may overestimating the host medium strength.</p>
Ansell [15]	Impact Test Rig	<p>Concrete cylinder, confined by steel tube, is used as the host medium. It allows to test bolts up to 3 m long.</p> <p>Allowing large length of encapsulation up to 1 m.</p>	<p>Loss of impact energy is not measured.</p> <p>The tendon is directly encapsulated inside the steel cylinder, may overestimating the host medium strength.</p> <p>The plastic deformation along the bolt length is not uniform as the impact duration (15 ms) was not enough. Only small-diameter rock bolts were tested.</p>
Gaudreau et al. [30]	NTC Impact Test Rig	<p>It allows to test bolts up to 1.7 m long.</p>	<p>The input energy is limited by the drop height.</p> <p>The scale of the rig do not allow higher drop weight and height.</p> <p>The tendon is directly encapsulated inside the small-diameter steel cylinder, may overestimating the host medium strength.</p> <p>Only rock bolts were tested.</p>
Player et al. [22]	WASM Impact Test Rig	<p>The drop weight and height allow large impact energy.</p> <p>The rock ejection process of rockburst phenomenon is simulated.</p> <p>It allows to test bolts up to 2.4 m long.</p> <p>Cable bolts were also tested.</p> <p>It is well-instrumented, allowing calculation of the energy absorbed by the different parts of the rig.</p>	<p>The tendon is directly encapsulated inside the small-diameter steel cylinder, may overestimating the host medium strength.</p> <p>At impact velocities more than 7 m/s, the rig's buffers (impact surface) damaged, which adversely affected the results.</p> <p>140 ms of impact duration is high and reduced the dynamic aspect of the test.</p>
Ortlepp and Erasmus [31]	SRK/Duraset Device	<p>Longer cable and rock bolts (up to 5 m long) can be tested as the specimens installed horizontally.</p> <p>The drop weight and height allows large impact energy.</p> <p>The system instrumentation allows to calculate energy consumption during the test.</p>	<p>The tendon is directly encapsulated inside the small-diameter steel cylinder, may overestimating the host medium strength.</p> <p>The available test results are limited.</p>

TABLE 2. Continued

1	2	3	4
Plouffe et al. [16]	CANMET-MMSL Rig	<p>It is a modified version of NTC rig. It allows to test bolts up to 2.1 m long.</p> <p>It is well-instrumented.</p> <p>Large impact energy could be applied.</p> <p>The impact duration (50-80 ms) is high enough to distribute the deformation uniformly along the bolt.</p>	<p>The tendon is directly encapsulated inside the small-diameter steel cylinder, may overestimating the host medium strength.</p> <p>It is well-instrumented.</p> <p>Only rock bolts were tested.</p>
Carlton et al. [32]	Rocktech Mt Charlotte Rig	<p>It can replicate the field condition.</p> <p>Both cable and rock bolts can be tested.</p>	<p>The test set-up is only suitable for in-situ tests.</p> <p>The impact energy is limited by the drop height and weight.</p> <p>The drop height is restricted by the excavation size.</p>
Pytlík [25]	GIG Impact Test Facility	<p>The test assembly allowed both static and impact loading, making it possible to compare the results of different loading modes.</p>	<p>The impact velocity is not enough to replicate the ejected rock velocity.</p> <p>The tendon is directly encapsulated inside the small-diameter steel cylinder, may overestimating the host medium strength.</p> <p>Only rock bolts were tested.</p> <p>Although the drop weight is large, the input energy is not high due to the low drop height.</p>
Li [33]	Drop Test Rig	<p>The test assembly allowed both static and impact loading, making it possible to compare the results of different loading modes.</p> <p>Concrete blocks, which were externally confined, were used as the host medium.</p>	<p>The impact energy is not enough to fail larger-capacity bolts.</p> <p>Only small-diameter bolts were tested.</p> <p>The shear box configuration caused energy consumption during the test.</p>
Crompton [34]	NCM DIT Rig	<p>It is allowed to have both single and double embedment configurations.</p> <p>It is able to apply large impact energy.</p> <p>The test assembly allows both static and impact loading, making it possible to compare the results of different loading modes. Besides, it is possible to apply static deformation prior to impact loading.</p>	<p>The tendon is directly encapsulated inside the small-diameter steel cylinder, may overestimating the host medium strength.</p> <p>Only rock bolts were tested.</p>

1	2	3	4
Aziz et al. [35] & Anzanpour [37]	Impact Drop Hammer Rig	The test assembly allows both static and impact loading, making it possible to compare the results of different loading modes. Both impact pull-out and shear tests can be done. Concrete blocks, which were internally and externally confined, were used as the host medium. Both cable bolt and rock bolts were tested. It is well-instrumented.	Only small-diameter rock bolts and low-strength cable bolts were tested under shear loading. The highest possible impact energy is not enough to shear high-strength cable bolts such as 63 t Sumo cables.
Pytlik [36]	Single Shear Test Rig	The test assembly allows both static and impact loading, making it possible to compare the results of different loading modes.	The drop height was low. The impact velocity was not enough to replicate the velocity of ejected rock. The shear rig was a guillotine-type device, underestimating the tendon shear resistance. Only rock bolts were tested.
Darlington [23]	Sandvik In-Situ Test Rig	It can replicate the field condition. Both cable and rock bolts can be tested. It is portable rig. It is able to test non-vertically installed bolts. It is well-instrumented.	The test set-up is only suitable for in-situ tests. The drop height and weight are restricted
Wang et al. [38]	Swing Hammer Rig	Concrete block is used as the host medium. Allowing large length of encapsulation up to 1.8 m.	The swing weight is low, creating low impact energy. Only rock bolts were tested.
Kang et al. [20]	Impact Pendulum Rig	The test assembly allows both static and impact loading, making it possible to compare the results of different loading modes.	The impact energy is very low. Only rock bolts were tested.

3. Performance of Tendons Under Impact Loading

General speaking, although the developed impact test rigs are not able to completely replicate the low frequency vibration of the large seismic events such as rockburst (since these rigs apply a single pulse), their application has brought engineers valuable and undeniable lessons in this field [5]. In the domain of impact testing of tendons, the volume of available research is considerably less than that of static loading studies. However, based on the literature, utilizing the impact test rigs, the parameters including host medium strength [27,24,38], tendon installation properties including angle of inclination and pre-tensioning load [20,24,26], impact energy

and multiple impacts [6,11,19,20,40], energy dissipation [41-43], Mass bounces [21], static deformation prior to impact loading [34,43], and tendon properties including profile geometry and diameter [33,37] have been studied over the last years (see Fig. 13). In the following, the research conducted on the behaviour of tendons under impact axial and shear loading have been investigated chronologically.

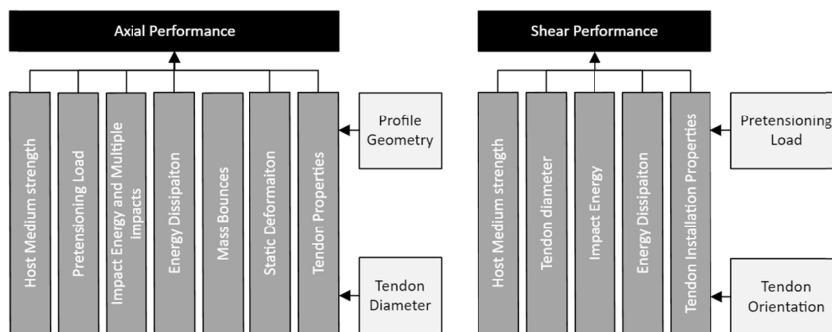

Fig. 13. The parameters which their effects on tendon behaviour were examined under impact loading mode

3.1. Axial Performance

Yan [27] utilized the drop weight impact test machine (see Fig. 3a and b) and reported that the bond between the rock bolt and the host medium can be affected by the bolt surface profile, host medium strength, and the rate of impact loading. In this research, only small diameter bolts were used, and it was found that the impact loading rate was not substantial for 11.3-mm smooth bars. Instead, for the threaded bar, the bond stress increased with the loading rate thanks to the presence of the bolt's ribs, specially near the loaded end. In addition, it was reported that the bond stress increased with host medium strength during the impact tests. The obtained results also shown that the bond stress generated in the pull-out test was lower than that of the push-out test, which is due to the larger radial force acting at the interface in push-in tests. This effect was also proved via static pull tests conducted by Aziz and Jalalifar [44]. Later, Yi and Kaiser [28] conducted impact tests employing the GRC weight drop rig (see Fig. 3c). They found if a rock bolt is plastically strained during multiple drop (i.e., impact loading), it will lead to the accumulation of plastic strains. Thus, the rock bolt will ultimately fail. It was concluded that the rock bolts, experiencing static elastic or plastic deformations prior to impact loadings, are vulnerable to fail at the presence of seismic events like rock burst. In another study, Ortlepp and Stacey [29] performed several impact tests using the SRK set-up #2 (see Fig. 4b). In this study, various tendons, including pre-tensioned 18-mm steel cables, 39-mm split sets, 16-mm rock bolts, and standard Swellex bolts, were tested. It was reported that the tested split sets allowed more displacements under the constant absorbed energy in comparison with cables and 16-mm rock bolts. Instead, the tested cables absorbed more impact energy but allowed lower displacement.

Ansell [15] and later Ansell [19] showed that the plastic strain distribution along the length of tested fully grouted energy absorbing bolts was not constant when they were dynamically loaded using the developed free-fall rig (see Fig. 5a). As shown Fig. 14, the plastic strain level varies from 0 to 50%. It was also shown that the bolt's yield length reduced with the impact velocity.

However, in this study, the effect of grout was not assessed and the impact energy taken-out by the rig's components was not considered. Gaudreau et al. [30] examined the modified cone bolt behaviour subjected to impact loading by using the NTC impact test set-up (see Fig. 5b). They showed that the outcomes of the tests was affected by the velocity of impact and the mass of drop weight.

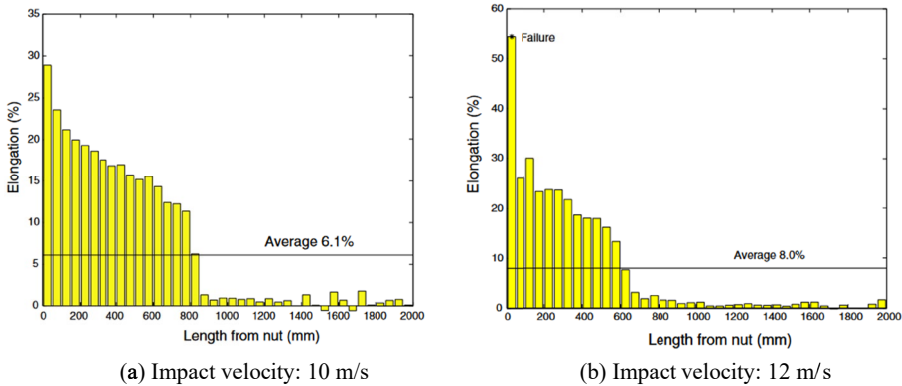

Fig. 14. Recorded plastic strain distribution along the bolt length [19]

Next, Thompson et al. [41] used the WASM dynamic test rig (see Fig. 6a) and estimated the energy dissipation by the interactions of the rig's components based on the Newton second law. For this, the instrumentation signals were filtered the force-displacement curves were assessed to calculate energy absorbed by system components. It was found that the around 50% of the input energy, resulted from the beam and the rock mass energies, was absorbed by the bolt, indicating that some of part of the input energy dissipated by the buffer. Later, Villaescusa et al. Villaescusa et al. (2005) tested 7-strand cable bolts dynamically by the WASM rig and calculated the energy absorption of the rig's parts based on the study conducted by Thompson et al. Thompson et al. (2004). In this study, a mass of 2000 kg was dropped from height of 1.85 m onto the test sample. Meanwhile, only two of the tests led to the cable pull-out and two of them led to the cable strand failure. It was found that the surface hardware (palate and barrel & wedge) must be used in order to mobilise the maximum strand force capacity as cables without the surface hardware failed by sliding along the grout column. Instead, it was found that when surface hardware were used, the cable strands failed during the test. It was reported that, in the tests causing cable failure, the absorbed energy by the cable was around 16 kJ, indicating that more than 70% of the total input energy (around 52 kJ) consumed by the rig's components. On the other hand, when the cables were pulled out, the energy absorption was relatively higher (16-42 kJ) although the obtained cable displacement (400-700 mm) might be unacceptable in the real field condition.

St-Pierre et al. [40] conducted impact tests using the CANMET-MMSL test rig (see Fig. 7a). First, they tested encapsulated cone bolts with the drop height 1.5 m and the drop weight of 1016 kg, resulting in 14.95 kJ of energy and 5.43 m/s of impact velocity. Through the first series of tests, it was found that two mechanisms can be considered for the bolt energy absorption:

- 1) The steel plastic deformation (permanent elongation).
- 2) The sliding of the bolt in the encapsulation medium (pull-out).

As can be seen from Fig. 15a, the cone displacement represents the bolt sliding in the grout and the difference between the cone and plate displacements refers to the permanent elongation of the bolt. It is clear that the permanent displacements occurred at the first impact. It was also shown in the tests conducted by St-Pierre et al. [12]. Also, it was reported by St-Pierre et al. [40] that although these two mechanisms are always present during the impact tests, but their ratios considerably differ from one test to the other with different impact velocities. For example, they found that the cone displacements increased with the impact velocity. They also investigated the failure of the bolts during the tests. It was found that even if the different combinations of drop height and weight resulted in the same impact energy, the combination used heavier mass led to more bolt's damage. Because the test carried out with the mass of 1016 and the drop height of 1.5 had a momentum of 5511 kgm/s while the test carried out with the mass of 1461 kg and the drop height of 1 m had a momentum of 6471 kgm/s. Thus, the momentum, which is the product of the mass of drop weight and the impact velocity, can influence the damage of tendons during the tests.

St-Pierre et al. [42] examined the energy balance during the impact tests conducted by the CANMET-MMSL test rig to show if the energy conservation principle was respected. For this aim, they divided the energies involved in the dynamic test into four states as follow:

- 1) The potential energy of the weight before being dropped. Therefore, the final position of the plate after the drop refers to the zero potential energy.
- 2) The maximum kinetic energy when the dropped mass strikes the plate. The velocity for calculating the kinetic energy was attained by differentiating the filtered signal of the potentiometer attached to the drop weight to record its position.
- 3) The energy absorbed by the plate (the work done by the plate load), calculated by integrating the plate load over the plate displacement.
- 4) They total energy absorbed by the bolt due to the steel plastic deformation and cone sliding in the grout. The energy absorbed by the steel elongation (strain energy) was calculated by integrating the force-displacement plot, and the energy dissipated by the cone sliding (cone work) was calculated by integrating the cone load over the cone displacement.

As shown in Fig. 15b, the differences between the kinetic and potential energies in various tests were negligible, indicating that energy dissipated by friction of the mass on the guiding rails was considerably low. Meanwhile, there were differences between the obtained kinetic energies and the energies absorbed by the plates (i.e., plate work) during the tests, indicating that some parts of the kinetic energy might be dissipated due to the noise and permanent deformation of the plate. In addition, in the majority of the tests, the total energy absorbed by the bolt (i.e., strain energy plus cone work) was close to the plate work, which was considered satisfying.

Plouffe et al. [16] also used the CANMET-MMSL test rig to examine the influence of temperature on the performance of modified cone bolts. Based on the obtained results, at the ambient temperature and at 40°C, there was no considerable difference in the plate load and displacement. However, at 40°C, after a few drops, the cone sliding was stopped, which might be due to the steel fatigue. Player et al. [11] and later Player et al. [13] used the WASM dynamic test rig to test different tendons, including 22-mm cone bolts, 15.2-mm plain cables, fully grouted 20-mm thread bars, and debonded 20-mm thread bars. As shown in Fig. 16a, it was found that if the embedment length of the plain cable is less than 2 m, the cable slip will occur (e.g., test 23); otherwise it will fail (test 19 and test 22). It was also shown that the dynamic capacity of the tested plain cables was enhanced when the face plate was employed during the tests. In addi-

tion, since the influential parameters (e.g., embedment length) were not kept constant during the tests, the influence of impact velocity was not conclusive. Fig. 16b shows that, in the case of cone bolts, the loading capacity of the bolt improved with the strength of the encapsulation medium. Similarly, the influence of the impact velocity was not conclusive due to the variable test parameters (e.g., encapsulation medium).

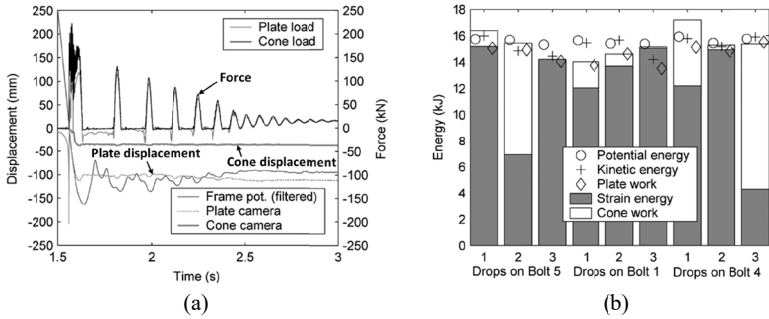

Fig. 15. (a) the force and displacement measured versus time during the impact tests [40] and (b) the comparison of different energy states in the dynamic tests (In all tests, the drop weight and mass were 1461 kg and 1 m, respectively) [42]

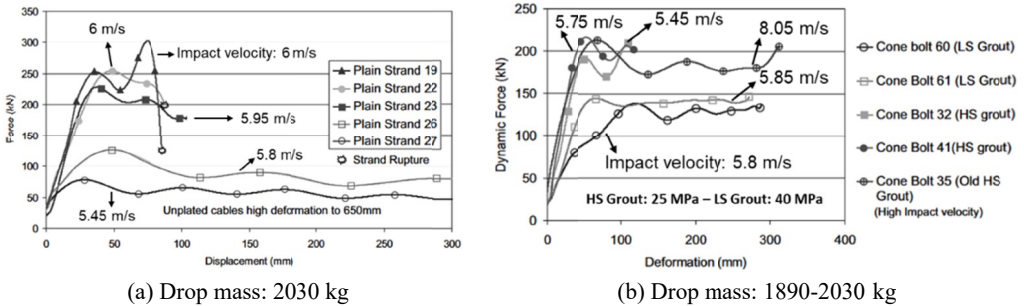

Fig. 16. The dynamic load-displacement plots for various types of tendons tested using the WASM dynamic test rig, adapted from [11]

In another research, St-Pierre et al. [12] divided the loading signal, collected during a drop test by the CANMET-MMSL test rig, into three parts as follow (Fig. 17a):

- 1) The first impact (the most important part in terms of loading amplitude and impact duration, producing permanent displacements).
- 2) The elastic rebounds (a series of rebounds of the dropping mass on the plate of the bolt).
- 3) The system equilibrium (the system reaches equilibrium through a series of damped oscillations).

As shown, during the first impact, there is a load drop in the loading curve which means that the bolt starts to slide in the grout. St-Pierre et al. [12] also compared the plastic deformation distribution along the bolt length with results obtained by Ansell [15]. As show in Fig. 17b, in both

first and second drops, the variation of the plastic strain along the bolt was roughly between the 1% and 4%, which is far less than 25% variation reported by Ansell [15]. Because, in the tests conducted by the CANMET-MMSL rig, the impact duration was around 50-80 ms while in the rig used by Ansell [15] it was about 15 ms. Hence, the longer impact duration allows the plastic wave front to travel the entire length of the bolt, producing a fairly uniform strain distribution.

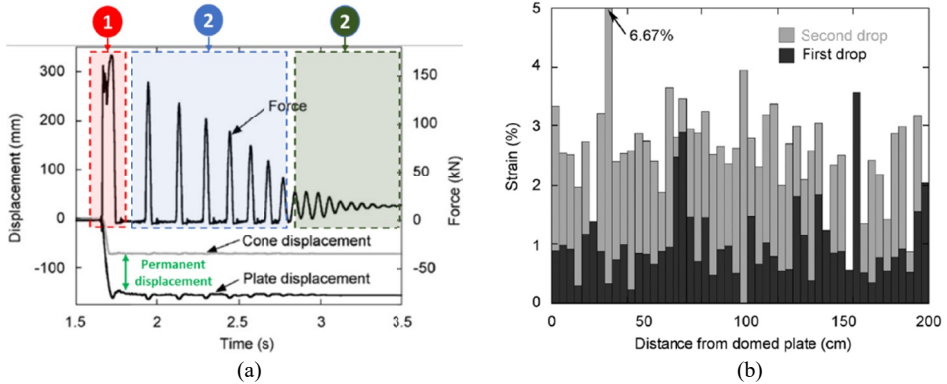

Fig. 17. (a) the parts of force signal measured during the impact tests and (b) the distributions of the plastic deformation along the bolt length adapted from [12]

Li [46] carried out drop tests using the CANMET-MMSL rig to assess the dynamic energy absorption capacity of 20-mm D-bolts. D-bolt is a smooth steel bar designed with several anchors along its length. When it is under stress, the smooth section deforms freely, and the anchored section being designed to create a firm bonding between the grout and the bolt. In this study, for every test, the drop mass and height were 893 kg and 1.5 m, and the bolt was encapsulated with 28-mm resin cartridges in a 32-mm diameter 12-mm thick split steel tube. The typical plots of the impact load and the plate load recorded during a drop is shown in Fig. 18a. As can be seen, a small portion of the impact load (about 25%) was transferred to the plate, indicating that the bolt was able to absorb a noticeable amount of the input impact energy. In addition, the differ-

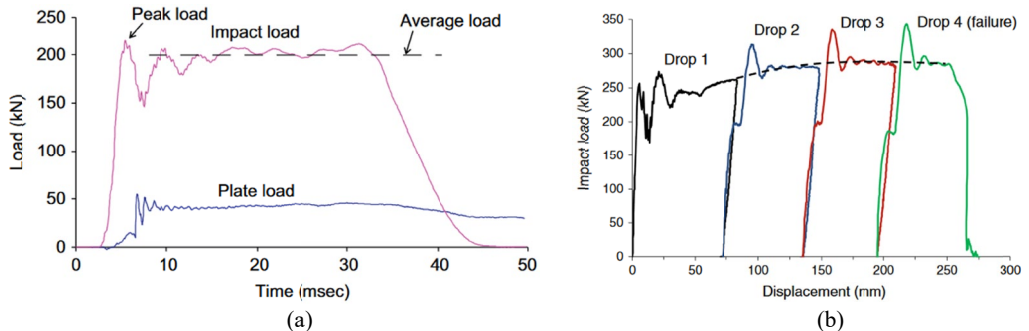

Fig. 18. (a) the impact and plate loads recorded during the first drop [46] and (b) the results of an impact test with multiple small-magnitude drops [6]

ence between the ultimate impact load and the average load (residual load) was not considerable, and under this load level, which was slightly close the bolt material strength, the bolt elongated between 14-20%. Later, Li and Doucet [6] reported that, in the multiple drops test, the ultimate deformation of the test section was 10-20% larger than the single drop tests, indicating that the D-bolt might be able to absorb marginally more energy when it is subjected to the number of small seismic events than when it is subjected to a single- and large-seismic event possibly because of the strain-hardening effect of the impacts on the steel (see Fig. 18b).

Pytlik [25] used GIG impact test facility (see Fig. 8a) and dynamically tested the rock bolts with the impact velocities varied from 0.6 to 0.8 m/s. It was found that when the curing time of the grout increased from 14 to 21 days, at the same impact velocity of 0.7 m/s, the ultimate dynamic load for debonding the rock bolt increased from 230 kN to 420 kN. Pytlik and Szot [47] also tested 15.7 mm cable bolts using the same test facility, and it was found that the influence of impact loading has a great influence on decreasing the LTC of the cable, resulting in the brittle cracking of the cable strands. They also compared the static and impact tests results and showed that the absorbed energy by the cable until failure in impact loading was 48% less than that of in static loading. Knox and Berghorst [48] dynamically tested the 20-mm PAR1 Resin Bolt using the NCM’s DIT rig (see Fig. 8b). This study aimed to examine if the changes in ground movement over time can reduce the dynamic capacity of the reinforcement system. Thus, before the impact tests, the test samples were elongated in the quasi-static mode from 40 mm to 100 mm; then, they were dynamically tested. Based on the results, the quasi-static elongation led to a higher impact ultimate load (Fig. 19a). It was also shown that the total displacement was also increased. In addition, it was reported that as some parts of the energy absorption capacity of the bolt were consumed during the quasi-static elongation, the dynamic energy absorbed by the bolt reduced during the test. These effects were also reported by Crompton and Knox [43] using the same impact rig and bolt (Fig. 19b). It shows that the bolt capacity to absorb dynamic energy is reduced with quasi-static elongation either for 20- or 22-mm diameter bolts. It can be seen that regardless of the level of the quasi-static elongation, the energy absorption capacity of the bolt increased with the diameter, especially when there was no primary quasi-static elongation.

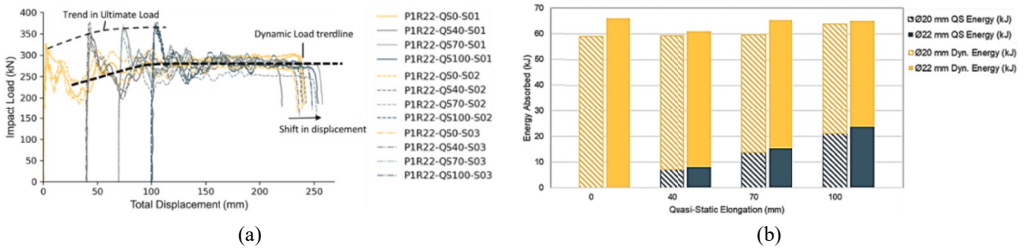

Fig. 19. The effect of the static elongation on the dynamic performance rock bolt (a: [48] and b: [43])

Li et al. [21] dynamically tested the rock bolts using the CANMET-MMSL test rig and examined if the mass rebounds after the first impact contribute to plastic deformations in the rock bolts. As shown in Fig. 20, it was concluded that after the first impact, the peak loads of the next bounces were less than the yield load of the bolt shank. Thus, the first impact played the main role, and the next bounces could not result in any further bolt plastic deformation. Anzanpour

et al. [49] carried out dynamic pull-out tests using the drop hammer rig (see Fig. 9a). It was found that the dynamic pulling force of the MW9 cable bolt was 30% lower than the force used in the static pull-out tests. Because the impact load is applied in a fraction of time which eliminates the effect of friction. In addition, Anzanpour et al. [37] carried out static and dynamic pull-out tests on 63 t Sumo cable bolts. Fig. 21a shows that the average load level of the bulbed cable bolts seems to be higher than that of plain cables. Meanwhile, as demonstrated in Fig. 21b, it was reported that when other factors such as embedment length (300 mm) and concrete strength were constant, a greater normalized pull-out energy was required in static mode in comparison with dynamic mode. It was concluded that bulbed cables are more reliable options in dynamically active zones as they could absorb more energy under dynamic loading condition. However, more tests should be undertaken to make a specific conclusion about the influence of bulbing on the cable axial performance under impact loading.

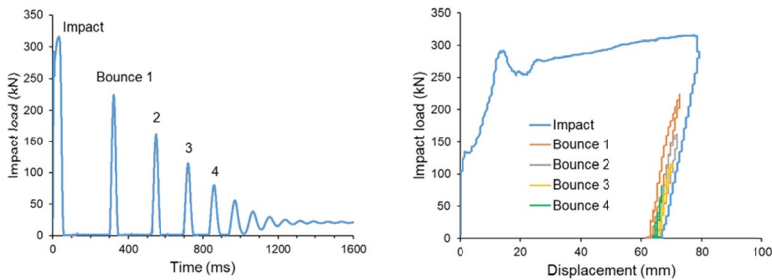

Fig. 20. The influence of the next bounces on the deformation in impact testing [21]

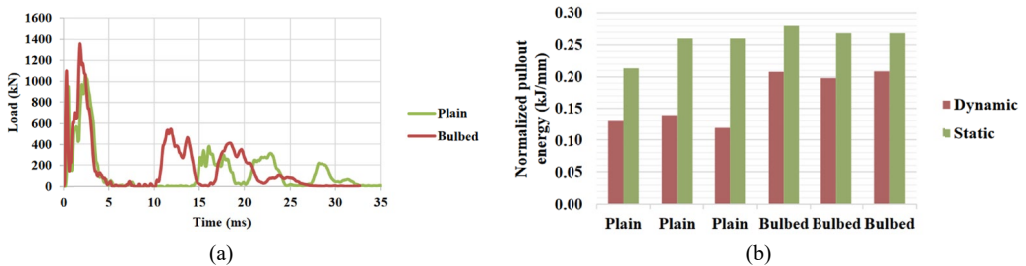

Fig. 21. (a) load-time curves obtained from impact tests and (b) energy absorption in static and dynamic pull-out testing of various cables [37]

Wang et al. [38] used the swing hammer test set-up (see Fig. 10a) to conduct impact testing of 18-mm Glass Fibre Reinforced Polymer (GFRP) rock bolts. In this study, 1.6 m of the bolts' length were encapsulated in the concrete blocks with three different sizes. The bolts were instrumented with strain gauges and the level of impact force was changed by using different hammer weights and swing angles. According to the results, the highest axial force occurs at the bolt collar. It was concluded that the most damage to the rock bolt occurs around the bolt head location, and the axial force along the bolt increases with the impact force. Meanwhile, it was reported that the speed of axial force attenuation along the bolt increased with the host medium strength.

However, when the results are compared, this conclusion is not satisfied. Later, Kang et al. [20] employed the impact pendulum test set-up (see Fig. 10b) to test 22-mm rock bolts. It was found that with greater pretension load (80% of yield load), the first peak of the impact load was greater than those of the subsequent peaks. In addition, at the same pre-tension load, it was shown that as the impact energy increased, the rate of bolt deformation as well as the ultimate deformation increased. It was found that at the lowest impact energy (i.e., when the peak impact load was below the elastic limit of the bolts), no plastic deformation was observed in the bolt. However, as the energy increased gradually and the peak impact load exceeded the elastic limit, the plastic deformation steadily increased.

3.2. Shear Performance

Li [33] conducted impact Double Shear Test (DST) using the drop test rig (see Fig. 11a) and found that the failure characteristic of the 8-mm rock bolt was affected by the host medium integrity. The crushed zones near the shear planes led to the bolt tensile failure rather than shear failure. In addition, as can be seen in Fig. 22a, the bolt bending occurred in both 8-mm and 16-mm rock bolts. One reason for this bending movement is the weakness of the host medium and another one might be the position of the steel plates placed under the side blocks (Fig. 22b). The gap between the plates and the shear planes created a bending movement, consuming the impact energy during the test. In addition, the tested 16-mm bolts were not failed which might be due to the size of the rig or the weakness of the host medium. It was also reported that the failure of 8-mm inclined rock bolts needed more absorbed energy than that of 8-mm horizontal rock bolts. However, it was not possible to measure the required energy for rupturing the 16-mm rock bolts [26].

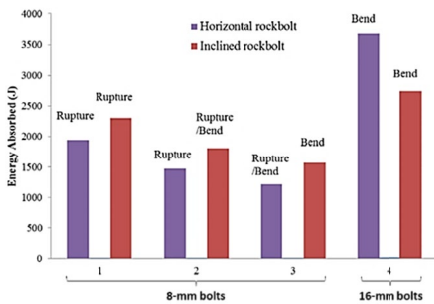

(a) Test results

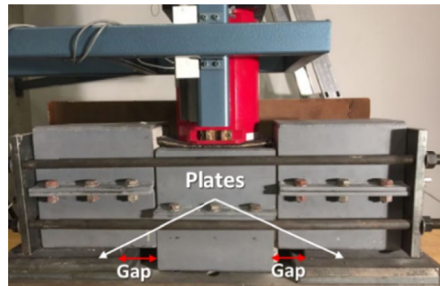

(b) Gap between the shear planes and the plates

Fig. 22. The dynamic shear testing of bolts with different angles of inclination and diameter [33,26]

Aziz et al. [35] used the drop hammer rig (see Fig. 11b) to test 18-mm rock bolts under impact loading. In this study, to enhance the integrity of the host medium, internal confinement was employed. As shown in Fig. 23a, they divided the first impact into three stages. In the first stage, the dropping hammer contacted the plastic rubber and compressed it until the central block commenced bearing the load. In stage 1, while the velocity of the middle block increased, the velocity of the drop weight reduced. The second stage occurs when both the drop weight and the middle block move downwards together, producing a low-frequency oscillation in the impact

load-time curve. This low-frequency oscillation is the interaction force between the impactor and the specimen, which results in the energy being stored elastically and plastically in the rock bolt. Since the stress changes dramatically in this stage, the bolt plays an essential role in resisting any changes. Finally, the last stage occurs when the bolt fails. Because the dynamic force induced by the drop hammer is greater than the bolt shear strength. Moreover, as shown in Fig. 23b, less energy was absorbed in dynamic tests in comparison with static tests either with or without internal confinement. It was concluded that friction is a time-related factor and in dynamic test, load is applied in a fraction of time which eliminates the frictional resistance of the shear planes.

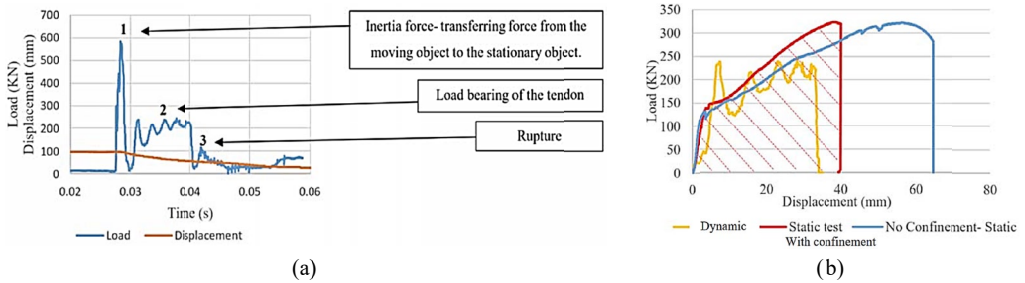

Fig. 23. The results of dynamic shear testing of rock bolts [35]

Anzanpour [50] used the drop hammer rig to conduct impact shear testing of cable bolts. In this research, the axial movement of the cable was restricted by barrel & wedges, and the initial pre-tension load was 50 kN. A trial test showed that the highest possible impact energy did not lead to the failure of the high-strength 63 t Sumo cable. Instead, in the case of 15.2-mm cables, it was found that when the absorbed energy was higher than 12 kJ, the cables failed. It was reported that the applied load could not be the only determinative factor for tendon failure as inertial force played a dominant role in resisting the applied impact force. In addition, it was shown that the applied shear load for each test is equal to the average of the peak loads after the inertia stage, if there are several peak loads during the loading stage (Fig. 24b). Khaleghparast

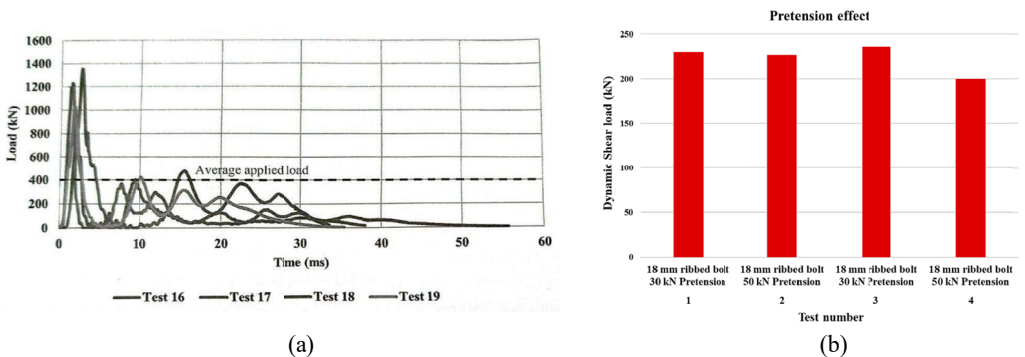

Fig. 24. (a) the average applied shear load in impact shear loading [50] and (b) the influence of pre-tension load on the impact peak load [24]

et al. [24] used the drop hammer rig to test 18-mm rock bolts. It was found that both the strength of the host medium and the internal confinement affect the transmission of the energy to the bolt in impact loading. In addition, it was reported that when 20-MPa concrete blocks were used as the host medium, most of the impact energy was consumed by the concrete sample, resulting in an extensive crush zone without shearing the bolt. In addition, it was also shown that the influence of the pre-tension load on the peak impact shear load is not conclusive (Fig. 24b), and more tests are needed to be undertaken.

4. Discussions

4.1. Challenging Aspects in Impact Testing of Tendons

There are some aspects which make the impact testing a challenging procedure. In this regard, the scale of the test arrangement, the host medium type for replicating the in-situ condition, accounting the amount of impact energy dissipated during the tests, impact shear testing of tendons, the effective instrumentation of the test rig for measuring the loads and displacements accurately, and the capability of the test rig to allow both static and impact loading are some of the potential aspects which has been identified.

Test Scale: The scale of the test arrangement directly controls its applicability. Therefore, the majority of the current test designs were not targeting the performance of cable bolts, especially high-strength ones, and only focused on the dynamic behaviour of rock bolts. In this regard, the design of the test set-up may not allow testing of cable bolts. Since the maximum drop height and mass affect the level of applied kinetic energy, in some of the current rigs, the highest possible impact energy may not be sufficient for testing the higher strength cable bolts.

Energy losses: The amount of kinetic energy transferred to the test sample is different from the theoretical impact energy produced during the test as some parts of it dissipated in the components of the test rig. Therefore, if these losses are not accounted during the test data analysis, the results will not be representative.

Instrumentation: Acquiring reliable data during the tests is very essential, without which it is not possible to reasonably analysis the performance of the tendon under dynamic loading. The instrumentation of the test arrangement for measuring the loads, displacements, accelerations, and strains can be done using high-speed data acquisition methods.

Host medium type: Similar to static loading tests, in the impact tests, the host medium of the tendon plays an important role in its performance during the experiments. In many of the test set-ups, the tendons directly encapsulated within the steel tubes. Since the stiffness of the steel is higher than that of the rock mass in the field condition, the obtained results might be overestimated. On the other hand, in the other rigs like the combination of the drop hammer rig and RPTM, the tendons were anchored in the concrete cylinders to simulate the in-situ condition as much as possible.

Comparing static and impact tests results: When the test assembly is designed for conducting both static and impact tests, it is possible to compare the performance of the tendon under different loading modes under constant test conditions like similar embedment length, host medium type, encapsulation medium and so on.

Impact shear testing: Based on the conducted literature review, it is clear that there are limited laboratory studies about the impact shear testing. Therefore, it seems that the impact shear

testing is relatively difficult to undertake in the laboratory compared to the dynamic pull-out test. Because, similar to static shear testing, the method is relatively recent with the general lack of trained expertise on the topic, indicating that this part of the research requires more investigation to be undertaken.

4.2. Future Research Directions

As shown in TABLE 3, in comparison with rock bolts, less investigation has been done on the dynamic performance of cable bolts. In addition, the majority of the researchers like Ortlepp and Stacey [29], Villaescusa et al. [45], Player et al. [13], and Anzanpour [50] only used lower strength cables (e.g., 7 wire strand, 15.2-mm, or 18-mm cables). When it comes to the dynamic behaviour of higher strength cables, the results of some experiments undertaken by Anzanpour et al. [49] and Anzanpour et al. [37] are only available in terms of pull-out testing. Thus, in order to improve our knowledge of dynamic performance of high-strength cables, further laboratory-based studies are required. High-strength cables are widely being used in underground spaces, but their dynamic capacity is still a topic of debate. Thus, dynamic testing of high-strength cables is an important research direction as a safety point of view. Besides, due to the absence of real test data regarding high-strength cables, the numerical models developed for the dynamic shear performance of high-strength cable bolts were only validated using the static shear test results, which might be misleading. Therefore, wider experimental works on dynamic shear performance of tendons can positively impact the accuracy of the numerical simulations. In addition, only Anzanpour et al. [37] examined the influence of the cable geometry (e.g., bulbing) in the axial impact loading mode. Although it was claimed that bulbed cable are more reliable in dynamically active zones, the number of tests might not be insufficient to make a specific conclusion. Therefore, to validate the previous results more tests should be undertaken in the future.

The literature review showed that a few laboratory-based studies and has been done to assess the shear behaviour of tendons subjected to dynamic loading (see TABLE 3). In this regard, only Li et al. [26], Aziz et al. [35], Anzanpour [50], and Khaleghparast et al. [24] conducted double shear tests, and Pytlik [36] used the single shear impact test rig. Among these studies, only Anzanpour [50] carried out a few dynamic shear testing of cables, which most of them were low-strength cables. Thus, it is clear that to fully understand the dynamic behaviour of cables, especially higher strength ones, more tests should be done. Besides, the influence of the cable profile geometry can also be evaluated.

Another issue is the effect of tendon pre-tensioning on dynamic behavior of tendons. Pre-tension load can act as a double-edge sword. High pretension load increase the axial force along the tendon and increases the shear forces along the gout-tendon interface and may lead to bond failure. Besides, Excessive pretensioning can reduce the tendon flexibility, which adversely affect its capability to accommodate large rock deformation. On the other hand, insufficient pretension loads may lead to joints and bedding plane dilation and roof sagging. However, when optimal pretension load is applied, more active support will be transferred to the rock mass resulting in less rock deformation and better ground control [51]. In impact shear tests, only Khaleghparast et al. [24] examined this factor but the results were not sufficient for making a concrete conclusion. Hence, assessing the influence of pre-tensioning can be another research direction.

According to the reviewed studies, there are limited results about the influence of tendon diameter on its dynamic performance. In this regard, some experimental and numerical results have

been reported by Crompton and Knox (2022) and Marulanda et al. [52], respectively, requiring more investigations for making concrete conclusions. Another issue is that the majority of the developed test arrangement have employed steel cylinders as the host medium for encapsulating the tendon (see TABLE 3). Host medium strength plays a major role in the LTC of tendons [53]. Hence, a steel tube, which provides stiff confinement, may overestimate the host medium strength and affect the test results [54]. In this regard, in the future research, concrete specimens, which are artificial rock samples can be used more as the host medium to replicate the filed condition as much as possible.

TABLE 3

Classification of the research carried out on impact testing of tendons

Ref.	Test Type	Tested Tendon Type	Host Medium Type
Yan [27]	Pull-out	11.3 mm smooth bar	Concrete block
Yi and Kaiser [28]	Pull-out	6.35 mm steel rod	Steel cylinder
Ortlepp and Stacey [29]	Pull-out	18 mm cable, 39 mm split set, 16 mm rock bolt, and Swellex bolt	Steel cylinder
Ansell [15]	Pull-out	16 mm energy absorbing rock bolt	Concrete cylinder
Ansell [19]	Pull-out	16 mm energy absorbing rock bolt	Concrete cylinder
Gaudreau et al. [30]	Pull-out	17.2 mm modified cone bolt (MCB)	Steel cylinder
Thompson et al. [41]	Pull-out	Rock bolt	Steel cylinder
Villaescusa et al. [45]	Pull-out	7-strand cable bolt	Steel cylinder
St-Pierre et al. [40]	Pull-out	17 mm cone bolt	Steel cylinder
St-Pierre et al. [42]	Pull-out	17 mm cone bolt	Steel cylinder
Plouffe et al. [16]	Pull-out	17.2 mm modified cone bolt (MCB)	Steel cylinder
Player et al. [11]	Pull-out	15.2 mm plain strand cable bolt and 20 mm galvanised threadbar	Steel cylinder
Player et al. [13]	Pull-out	15.2 mm plain strand cable bolt and 20 mm galvanised threadbar	Steel cylinder
St-Pierre et al. [12]	Pull-out	17 mm cone bolt	Steel cylinder
Li [46]	Pull-out	20 mm D-bolt	Steel cylinder
Li and Doucet [6]	Pull-out	20 mm and 22 mm D-bolts	Steel cylinder
Pytlik [25]	Pull-out	22 mm yielding bolt	Steel cylinder
Knox and Berghorst [48]	Pull-out	20 mm PAR1 Resin Bolt	Steel cylinder
Crompton and Knox [43]	Pull-out	20 mm and 22 mm PAR1 Resin Bolts	Steel cylinder
Li [21]	Pull-out	22 mm threadbar	Steel cylinder
Anzpour et al. [49]	Pull-out	31 mm MW9 cable bolt	Concrete cylinder
Anzpour et al. [37]	Pull-out	28 mm 63 t Sumo cable bolt	Concrete cylinder
Pytlik and Szot [47]	Pull-out	15.7 mm cable bolt	No host medium
Wang et al. [38]	Pull-out	18-mm GFRP bar	Concrete block
Kang et al. [20]	Pull-out	22 mm rock bolt	Concrete cylinder
Li [33]	Shear	8 mm and 16 mm rock bolts	Concrete block
Li et al. [26]	Shear	8 mm and 16 mm rock bolts	Concrete block
Aziz et al. [35]	Shear	18 mm rock bolt	Concrete block
Anzpour [50]	Shear	15.2 mm cable bolt	Concrete block
Khaleghparast et al. [24]	Shear	18 mm rock bolt	Concrete block

Another important issue to be taken into consideration is the impact of static elastic or plastic deformations prior to impact loadings on the dynamic performance of tendons. Because ground movements can decay the LTC of tendons over their service lifetime. The tendon degradation is highly likely to jeopardize the underground structure safety as it has already lost some parts of its load bearing capacity before the major dynamic loading. Currently, millions of tendons have been installed to control ground movement in underground spaces worldwide. Many of them have suffered from degradation during their long-term service due to static deformation, corrosion, or mine-induced seismicity. These reinforcement systems are susceptible to failure and may even fail under lower levels of impact loads, extremely limiting the efficient development and utilization of tunnels and underground openings. In this regard, only Knox and Berghorst [48] and Crompton and Knox [43] only carried out experimental studies to show the effect of such deformation on the dynamic pull-out performance of rock bolts. Hence, a new research direction is to examine the influence of such static deformations on the dynamic capacity of the cable bolts during the pull-out testing. Similar to pull-out testing, the influence of ground movement and static deformation on the dynamic shear performance of tendons can also be assessed. There is no study which evaluate the impact of this factor on the dynamic capacity of tendons subjected to impact loading. Such deformations prior to dynamic loading may lead to system failure even due to the lower-magnitude seismic events. As a result, another research direction is to examine the influence of such static deformations on the dynamic shear capacity of tendons.

5. Conclusion

The application of tendon reinforcement systems in ground stabilization is now more widespread than ever. Therefore, to enhance the reliability and efficiency of these systems, it is completely essential to understand the underlying logic and relations among their design parameters. Although, over the previous decades, various aspects of rock reinforcement using tendons have been thoroughly covered by comprehensive studies, the performance of tendons subjected to ground seismicity is still a topic of debate. To enhance the performance of rock reinforcement systems against such seismic events, it is highly necessary to study the dynamic aspect of these systems. Thus, impact testing of tendon is required to increase the current knowledge about the dynamic behaviour of strong cables, and consequently enhance the safety and productivity of underground structures.

Based on the results, there are some aspects which make the impact testing a challenging procedure. It was found that the scale of the test arrangement determine its applicability. Thus, when the maximum drop weight or drop height are limited, higher strength tendons cannot be tested. If the energy dissipation due to the rig's components is not accounted during the test data analysis, the results will not be representative. Because the total input energy will not completely transfer to the tendon. In addition, the proper instrumentation of the test rig for recording the load and displacements is very important. Similar to static loading tests, in impact tests, the host medium plays an important role. In many of the test rigs, the tendons directly encapsulated within the steel tubes. Since the stiffness of the steel is higher than that of the rock mass in the field condition, the obtained results might be overestimated. Another point is that when the test set-up is designed for conducting both static and impact tests, it is possible to compare the performance of the tendon under different loading modes.

In dynamic pull-out tests of rock bolts, two primary mechanisms of energy absorption are identified: steel plastic deformation, which results in permanent elongation of the bolt, and the sliding of the bolt in the encapsulation medium. The first impact plays a key role in the energy absorption process, as it leads to significant permanent displacements. While the total input energy is important, the energy consumed in displacing the bolt is more reflective of the dynamic behavior, as some energy is lost during the bouncing of the drop mass and vibrations within the testing setup. The impact duration, which increases with higher impact energy, is also critical, as it allows for more uniform strain distribution along the bolt, improving its ability to absorb energy.

The dynamic loading process can be classified into three stages: the first impact, which generates the largest loading amplitude and results in permanent displacements; elastic rebounds, where the drop mass rebounds elastically off the bolt plate; and the equilibrium stage, where the system stabilizes through damped oscillations. The first impact itself can be divided into three phases: inertial loading, where the bolt is accelerated from rest; load bearing, where energy is stored elastically and plastically in the bolt; and rupture or failure when the load exceeds the bolt's strength. Notably, the role of inertial forces is more significant than the applied load in resisting impact forces, and a longer impact duration leads to more extensive plastic deformation along the bolt's length, enhancing energy absorption.

Tests also showed that bolts subjected to multiple smaller seismic events could absorb slightly more energy than bolts exposed to a single large event. This phenomenon is attributed to the strain-hardening effect of the impacts, which progressively strengthen the bolt. The study further indicated that bolts experiencing static elastic or plastic deformations prior to dynamic loading are more vulnerable to failure under seismic conditions. The diameter of the bolt was found to increase its energy absorption capacity, while quasi-static elongation of the bolt prior to dynamic loading led to reduced dynamic energy absorption. Finally, differences in energy absorption were noted between dynamic and static shear tests, with dynamic tests requiring less energy to fail the bolt, due to the time-dependent nature of frictional forces. The influence of pre-tension load on peak dynamic shear load remains inconclusive, highlighting the complexity of these dynamic interactions.

According to the reviewed literature, the limitations of the previous studies were identified and the research directions in both shear and axial performance of tendons under impact loading were described. Addressing the current limitations can enhance the current knowledge of this area of study, making underground excavation much safer.

References

- [1] T.A. Lang, Notes on rock mechanics and engineering for rock construction. University of California, Berkeley, USA (1962).
- [2] D.J. Hutchinson, M.S. Diederichs, Cablebolting in underground mines. BiTech Publishers, Richmond, B.C. (1996).
- [3] J. Hadjigeorgiou, Y. Potvin, Overview of dynamic testing of ground support. In Australian Centre for Geomechanics, p. 349-371 (2007).
- [4] H. Hagedorn, Load bearing behaviour of fully grouted anchors under shock loading. *Soil Dynamics and Earthquake Engineering* **13**, 89-95 (1994). DOI: [https://doi.org/10.1016/0267-7261\(94\)90002-7](https://doi.org/10.1016/0267-7261(94)90002-7)
- [5] J. Hadjigeorgiou, Y. Potvin, A Critical Assessment of Dynamic Rock Reinforcement and Support Testing Facilities. *Rock Mech. Rock Eng.* **44**, 565-578 (2011). DOI: <https://doi.org/10.1007/s00603-011-0155-4>

- [6] C.C. Li, C. Doucet, Performance of D-bolts under dynamic loading. *Rock Mechanics and Rock Engineering* **45**, 193-204 (2012). DOI: <https://doi.org/10.1007/s00603-011-0202-1>
- [7] M. Cai, Principles of rock support in burst-prone ground. *Tunnelling and Underground Space Technology* **36**, 46-56 (2013). DOI: <https://doi.org/10.1016/j.tust.2013.02.003>
- [8] A. Mottahedi, M. Ataei, Fuzzy fault tree analysis for coal burst occurrence probability in underground coal mining. *Tunnelling and Underground Space Technology* **83**, 165-174 (2019). DOI: <https://doi.org/10.1016/j.tust.2018.09.029>
- [9] M. Askaripour, A. Saeidi, A. Rouleau, P. Mercier-Langevin, Rockburst in underground excavations: A review of mechanism, classification, and prediction methods. *Underground Space* **7**, 577-607 (2022). DOI: <https://doi.org/10.1016/j.undsp.2021.11.008>
- [10] D.D. Tannant, R.K. Brummer, X. Yi, Rockbolt behaviour under dynamic loading: Field tests and modelling. *International Journal of Rock Mechanics and Mining Sciences & Geomechanics Abstracts* **32**, 537-550 (1995). DOI: [https://doi.org/10.1016/0148-9062\(95\)00024-B](https://doi.org/10.1016/0148-9062(95)00024-B)
- [11] J. Player, A. Thompson, E. Villaescusa, Dynamic testing of reinforcement systems, in 6th International Symposium on Ground Support in Mining and Civil Engineering Construction, p. 597-6220 (2008).
- [12] L. St-Pierre, F.P. Hassani, P.H. Radziszewski, J. Ouellet, Development of a dynamic model for a cone bolt. *International Journal of Rock Mechanics and Mining Sciences* **46**, 107-114 (2009). DOI: <https://doi.org/10.1016/j.ijrmm.2008.05.005>
- [13] J. Player, A. Thompson, E. Villasescusa, Dynamic testing of threadbar used for rock reinforcement, in M. Diederichs, G. Grasselli (Eds.), OCKENG09: Proceedings of the 3rd CANUS Rock Mechanics Symposium, Toronto, Canada (2009).
- [14] P.K. Kaiser, M. Cai, Design of rock support system under rockburst condition. *Journal of Rock Mechanics and Geotechnical Engineering* **4**, 215-227 (2012). DOI: <https://doi.org/10.3724/SP.J.1235.2012.00215>
- [15] A. Ansell, Testing and modelling on an energy absorbing rock bolt. In N. Jones, C. Brebbia (Eds.), *Royal Institute of Technology*, p. 417-426 (2000).
- [16] A. Plouffe, T. Anderson, K. Judge, Rock Bolt Testing Under Dynamic Condition at CANMET-MMSL. In 6th International Symposium on Ground Support in Mining and Civil Engineering Construction, Cape Town, South Africa (2008).
- [17] T.R. Stacey, E. Rojas, A potential method of containing rockburst damage and enhancing safety using a sacrificial layer. *J. S. Afr. Inst. Min. Metall.* **113** (2013).
- [18] C.C. Li, G. Stjern, A. Myrvang, A review on the performance of conventional and energy-absorbing rockbolts. *Journal of Rock Mechanics and Geotechnical Engineering* **6**, 315-327 (2014). DOI: <https://doi.org/10.1016/j.jrmge.2013.12.008>
- [19] A. Ansell, Laboratory testing of a new type of energy absorbing rock bolt. *Tunnelling and Underground Space Technology* **20**, 291-300 (2005). DOI: <https://doi.org/10.1016/j.tust.2004.12.001>
- [20] H. Kang, G. Yuan, L. Si, F. Gao, J. Lou, J. Yang, S. Dong, Mechanical behavior and failure mechanisms of rock bolts subjected to static-dynamic loads. *International Journal of Mining Science and Technology* **34**, 281-288 (2024). DOI: <https://doi.org/10.1016/j.ijmst.2024.02.007>
- [21] C.C. Li, J. Hadjigeorgiou, P. Mikula, G. Knox, B. Darlington, R. Royer, A. Pytlik, M. Hosp, Performance of identical rockbolts tested on four dynamic testing rigs employing the direct impact method. *Journal of Rock Mechanics and Geotechnical Engineering* **13**, 745-754 (2021). DOI: <https://doi.org/10.1016/j.jrmge.2021.01.003>
- [22] J. Player, E. Villaescusa, A. Thompson, Dynamic testing of rock reinforcement using the momentum transfer concept. In E. Villaescusa, Y. Potvin (Eds.), *Ground Support in Mining and Underground Construction*, Taylor & Francis Group, Perth, Western Australia, p. 327-340 (2004).
- [23] B. Darlington, O. Vallati, P. Young, A comparison between laboratory and in situ dynamic testing on the MDX bolt. In *Ground Support 2023: Proceedings of the 10th International Conference on Ground Support in Mining*, Australian Centre for Geomechanics, Perth, p. 361-370 (2023). DOI: https://doi.org/10.36487/ACG_repo/2325_24
- [24] S. Khaleghparast, N. Aziz, A. Remennikov, S. Anzanpour, An experimental study on shear behaviour of fully grouted rock bolt under static and dynamic loading conditions. *Tunnelling and Underground Space Technology* **132** (2023). DOI: <https://doi.org/10.1016/j.tust.2022.104915>

- [25] A. Pytlík, A methodology for laboratory testing of rockbolts used in underground mines under dynamic loading conditions. *J. South. Afr. Inst. Min. Metall.* **116**, 1101-1110 (2016). DOI: <https://doi.org/10.17159/2411-9717/2016/v116n12a2>
- [26] L. Li, P.C. Hagan, S. Saydam, B. Hebblewhite, C. Zhang, A Laboratory Study of Shear Behaviour of Rockbolts Under Dynamic Loading Based on the Drop Test Using a Double Shear System. *Rock Mech. Rock Eng.* **52**, 3413-3429 (2019). DOI: <https://doi.org/10.1007/s00603-019-01776-x>
- [27] C. Yan, Bond between reinforcing bars and concrete under impact loading. PhD, University of British Columbia (1992). DOI: <https://doi.library.ubc.ca/10.14288/1.0050492>
- [28] X. Yi, P.K. Kaiser, Impact testing for rockbolt design in rockburst conditions. *International Journal of Rock Mechanics and Mining Sciences & Geomechanics Abstracts* **31**, 671-685 (1994). DOI: [https://doi.org/10.1016/0148-9062\(94\)90007-8](https://doi.org/10.1016/0148-9062(94)90007-8)
- [29] W. Ortlepp, T. Stacey, Testing of tunnel support: dynamic load testing of rockbolt elements to provide data for safer support design. Safety in Mines Research Advisory Committee, (1998).
- [30] D. Gaudreau, M. Aubertin, R. Simon, Performance assessment of tendon support systems submitted to dynamic loading. In E. Villaescusa, Y. Potvin (Eds.), *Ground Support in Mining and Underground Construction*, Taylor & Francis Group, Perth, Western Australia, p. 548-573 (2004).
- [31] W.D. Ortlepp, P.N. Erasmus, Dynamic testing of a yielding cable anchors. In 3rd Southern African Rock Engineering Symposium (2005).
- [32] R. Carlton, B. Darlington, P. Mikula, In situ dynamic drop testing of the MD bolt at Mt Charlotte Gold Mine. In *Proceedings of the Seventh International Symposium on Ground Support in Mining and Underground Construction*, Australian Centre for Geomechanics, Perth, p. 207-219 (2013). DOI: https://doi.org/10.36487/ACG_rep/1304_13_Mikula
- [33] L. Li, Investigation into shear performance of rockbolts under static and dynamic loading conditions. UNSW Sydney (2016). DOI: <https://doi.org/10.26190/UNSWORKS/19310>
- [34] B. Crompton, A. Berghorst, G. Knox, A new dynamic test facility for support tendons. *Australian Centre for Geomechanics Newsletter* **47**, 3-5 (2018).
- [35] N. Aziz, S. Khaleghparast, S. Anzanpour, A. Remennikov, A. Mirzaghobanali, Static and dynamic testing of tendons. *E3S Web Conf.* **192**, 01005 (2020). DOI: <https://doi.org/10.1051/e3sconf/202019201005>
- [36] A. Pytlík, Comparative Shear Tests of Bolt Rods under Static and Dynamic Loading. *Studia Geotechnica et Mechanica* **42**, 151-167 (2020). DOI: <https://doi.org/10.2478/sgem-2019-0038>
- [37] S. Anzanpour, N. Aziz, A. Remennikov, J. Nemcik, A. Mirzaghobanali, A. Rastegarmanesh, Laboratory study of the behaviour of grouted cable bolts under static and dynamic axial loading. In *IOP Conference Series: Earth and Environmental Science*, Institute of Physics (2023). DOI: <https://doi.org/10.1088/1755-1315/1124/1/012095>
- [38] W. Wang, L. Yu, C. Xu, C. Liu, H. Wang, J. Ye, Experimental and Numerical Study of the Dynamic Mechanical Behavior of Fully Grouted GFRP Rock Bolts. *Int. J. Geomech.* **23**, 04023147 (2023). DOI: <https://doi.org/10.1061/IJGNAI.GMENG-8771>
- [39] W. Ortlepp, T. Stacey, Testing of tunnel support: dynamic load testing of rock support containment systems. Safety in Mines Research Advisory Committee (1997).
- [40] L. St-Pierre, F.P. Hassani, J. Ouellet, P.H. Radziszewski, An Investigation on the Dynamic Testing Properties and Responses of Support Systems. In 11th Congress of the International Society for Rock Mechanics, Taylor & Francis Group, p. 175-178 (2007).
- [41] A.G. Thompson, J.R. Player, E. Villaescusa, Simulation and analysis of dynamically loaded reinforcement systems. p. 341-358 (2004).
- [42] L. St-Pierre, F.P. Hassani, P.H. Radziszewski, J. Ouellet, M. Plouffe, Testing and analyzing the dynamic response of rock support elements. In 4th Int. Symp. on High-Performance Mine Production, p. 353-368 (2007).
- [43] B. Crompton, G. Knox, Dynamic testing: determining the relationship between rockbolt diameter and the residual dynamic capacity of an axially strained tendon. In *Caving 2022: Fifth International Conference on Block and Sublevel Caving*, Australian Centre for Geomechanics, Perth, p. 141-150 (2022). DOI: https://doi.org/10.36487/ACG_repo/2205_07
- [44] N. Aziz, H. Jalalifar, The role of profile configuration on load transfer mechanism of bolt for effective support. *Journal of Mines, Metals and Fuels* **55**, 539-545 (2007).

- [45] E. Villaescusa, A. Thompson, J. Player, Dynamic testing of rock reinforcement systems. In CRC Mining Australian Mining Technology Conference-New Technologies to Produce More with Less (2005).
- [46] C.C. Li, A new energy-absorbing bolt for rock support in high stress rock masses. *International Journal of Rock Mechanics and Mining Sciences* **47**, 396-404 (2010). DOI: <https://doi.org/10.1016/j.ijrmms.2010.01.005>
- [47] A. Pytlik, M. Szot, Comparative Testing of Cable Bolt and Wire Rope Lacing Resistance to Static and Dynamic Loads. *Archives of Mining Sciences* **68**, 4, 707-724 (2023). DOI: <https://doi.org/10.24425/ams.2023.148158>
- [48] G. Knox, A. Berghorst, Dynamic testing: determining the residual dynamic capacity of an axially strained tendon. In Proceedings of the Ninth International Symposium on Ground Support in Mining and Underground Construction, Australian Centre for Geomechanics, Perth, p. 231-242 (2019). DOI: https://doi.org/10.36487/ACG_rep/1925_14_Knox
- [49] S. Anzanpour, N. Aziz, J. Memcik, A. Mirzaghorbanali, J. Wallace, T. Marshall, S. Khaleghparast, Introduction to new methods of static and dynamic pull testing of rock bolts and cable bolts. In N. Aziz, A. Mirzaghorbanali (Eds.), Proceedings of the 2021 Resource Operators Conference, University of Wollongong, University of Wollongong, NSW, Australia, p. 210-217 (2021). <https://ro.uow.edu.au/coal/811>
- [50] S. Anzanpour, The Load Transfer Mechanism of Ground Tendons Subjected to Static and Dynamic Loading Conditions. PhD, University of Wollongong (2022). <https://ro.uow.edu.au/theses1/1608/>
- [51] X. Li, G. Si, J. Oh, P. Corbett, T. O'Sullivan, Z. Xiang, N. Aziz, A. Mirzaghorbanali, Effect of pretension on the performance of cable bolts and its optimisation in underground coal mines with various geological conditions. *International Journal of Rock Mechanics and Mining Sciences* **152** (2022). DOI: <https://doi.org/10.1016/j.ijrmms.2022.105076>
- [52] L.Y. Marulanda, J.A. Vallejos, J.I. Velásquez, Explicit Numerical Study on Dynamic Behavior of Threadbar under Impact Loading (2024). DOI: <https://doi.org/10.20944/preprints202404.0192.v1>
- [53] N. Aziz, G. Yang, S. Khaleghparast, T. Marshall, Development of double shear testing of tendons. In N. Aziz, B. Kininmonth (Eds.), Proceedings of the 2019 Coal Operators' Conference, University of Wollongong, University of Wollongong, NSW, Australia, p. 150-161 (2019). <https://ro.uow.edu.au/coal/732/>
- [54] A. Mottahedi, N. Aziz, A. Mirzaghorbanali, A. Remennikov, S. Anzanpour, Aspects of testing tendon supports for strength, effective installation, and performance in different ground formation. In Proceedings of the 2024 Coal Operators' Conference, University of Wollongong, University of Wollongong, NSW, Australia, p. 146-169 (2024). <https://ro.uow.edu.au/coal/914/>